

YAS 68 - 04
KAPI KANAT PROF.
2.135 Kg/m

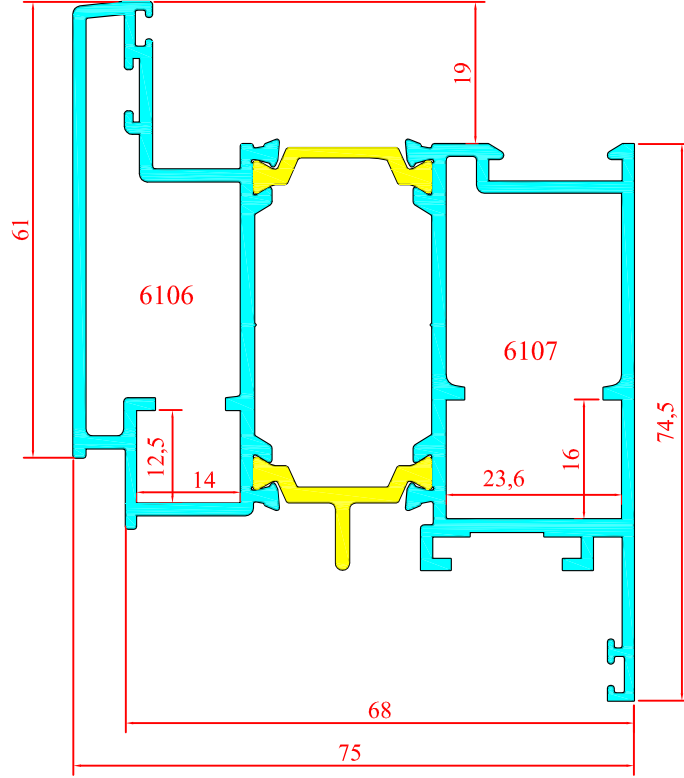

AS 15 - 6265
KAPI ALTI ADAPTÖR PROF.
0.793 Kg/m

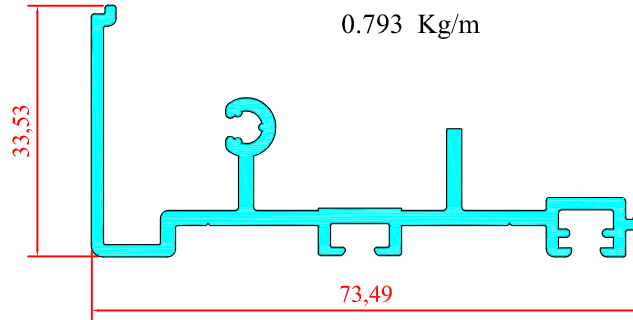

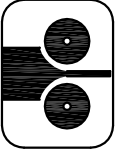

YAS 68 - 05
DIŞA AÇILIM KAPI KANAT PROF.
2.110 Kg/m

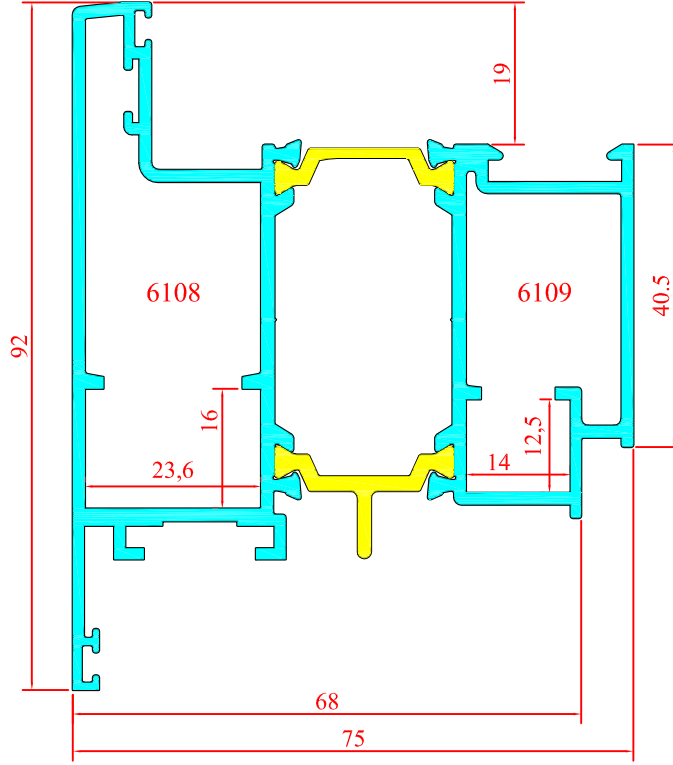

YAS 68 - 06
ORTA KAYIT PROF.
1.982 Kg/m

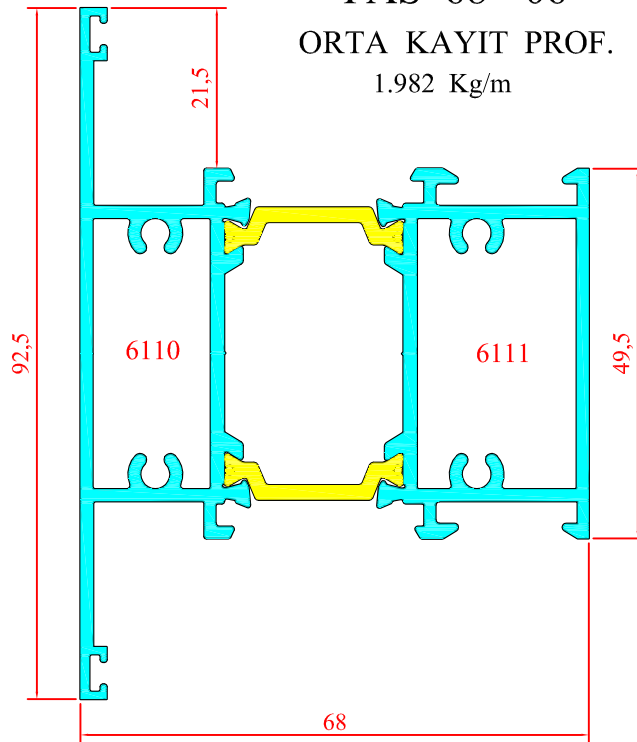

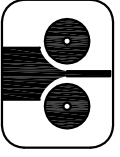

ALÇIN
Alüminyum A.Ş.

YALITIMLI AÇILIR SERİ

YAS 68 - 07

ETEK PROF.

2.920 Kg/m

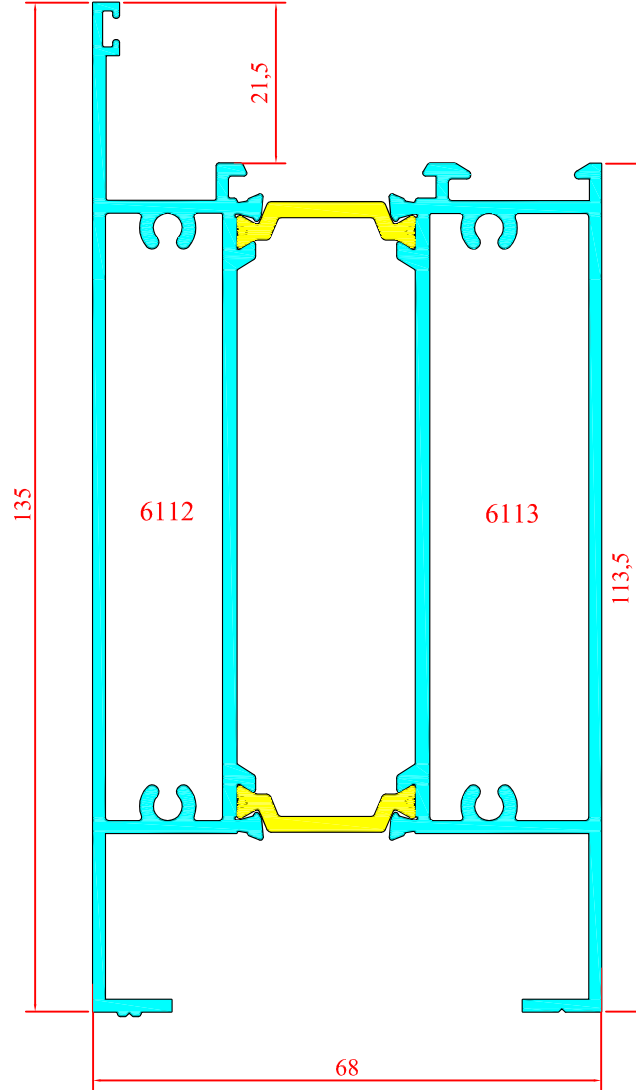

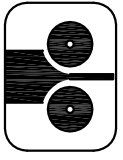

AS 01 6251
ÇİFT CAM ÇITA PROF.
0.317 Kg/m

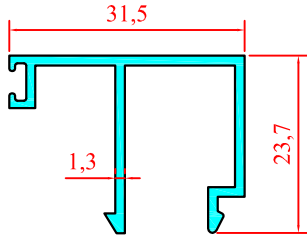

AS 01 6253
ÇİFT CAM ÇITA PROF.
0.300 Kg/m

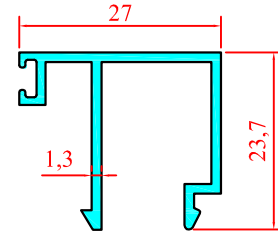

AS 01 6254
TEK CAM ÇITA PROF.
0.240 Kg/m

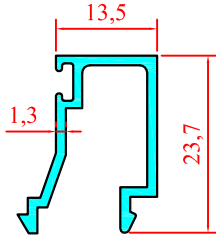

AS 01 6252
TEK CAM ÇITA PROF.
0.380 Kg/m

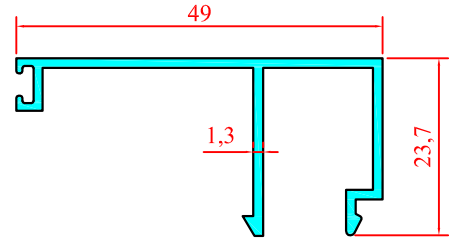

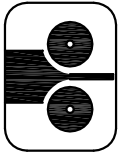

KASA PROF.

YAS 68 - 01

1.577 Kg/m

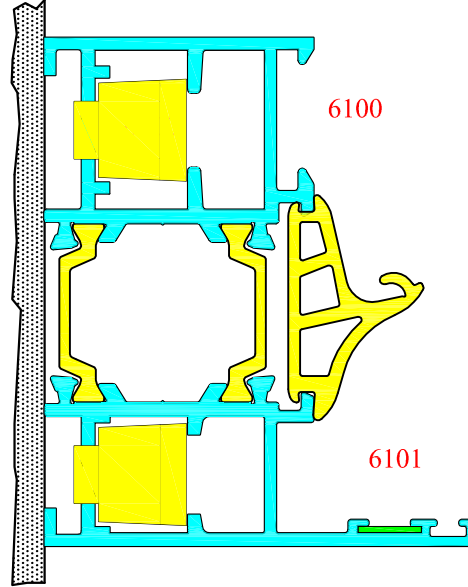

KANAT PROF.

YAS 68 - 02

1.612 Kg/m

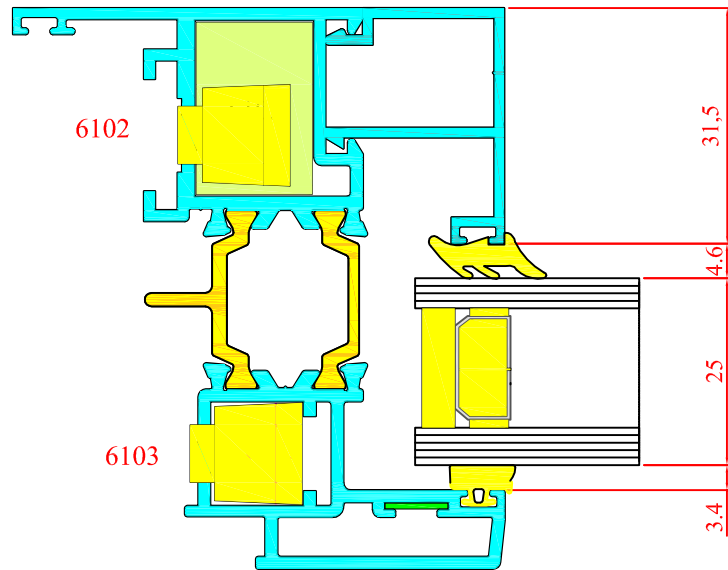



ALÇIN
Alüminyum A.Ş.

YALITIMLI AÇILIR SERİ

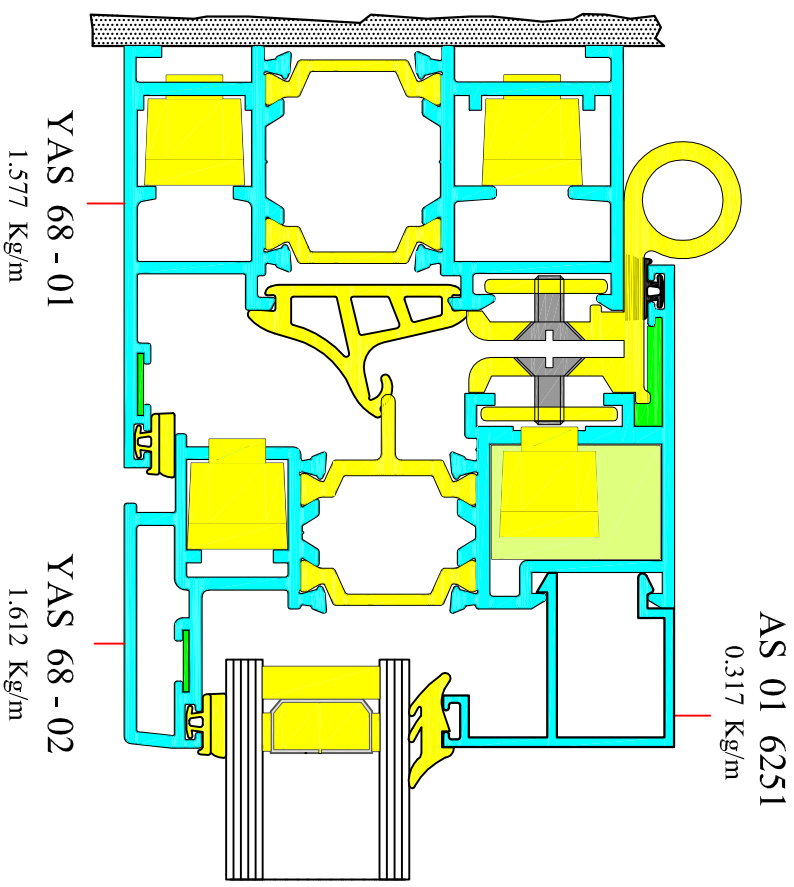
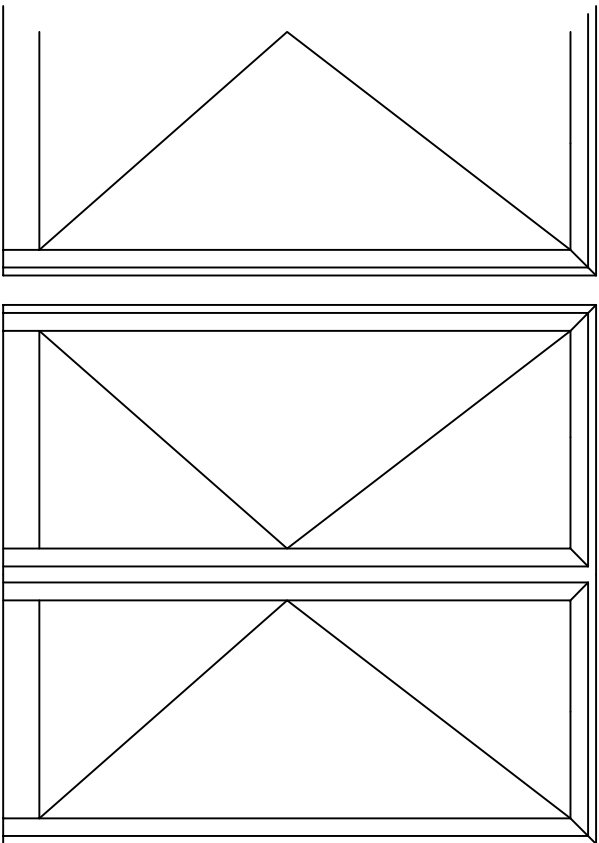

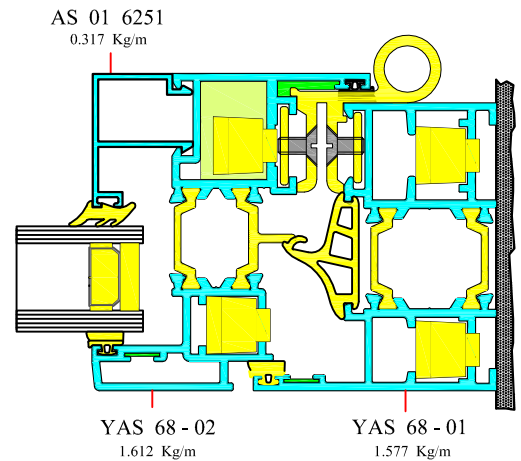
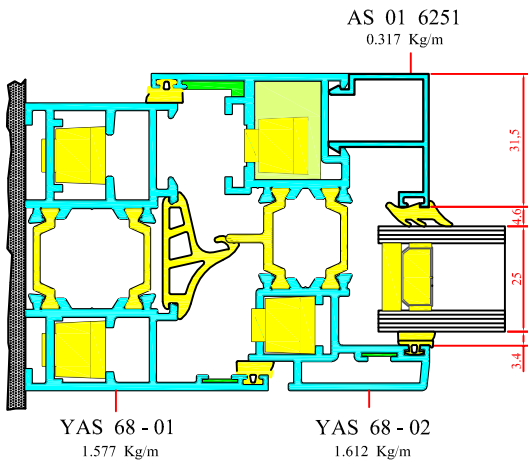
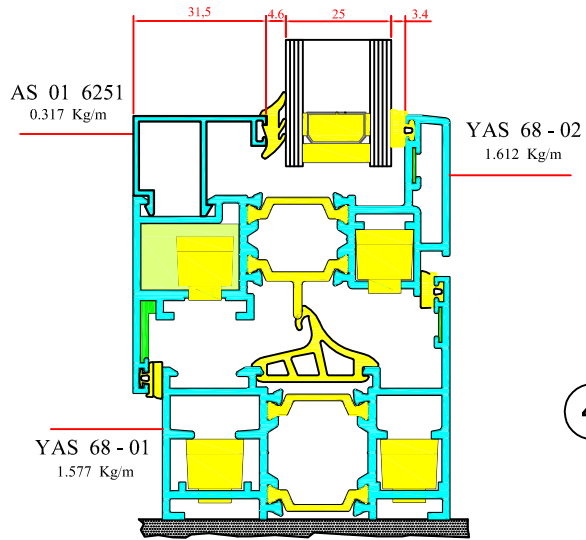
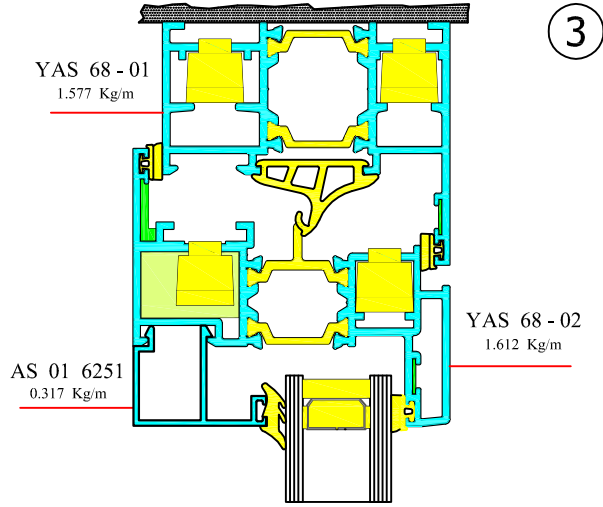
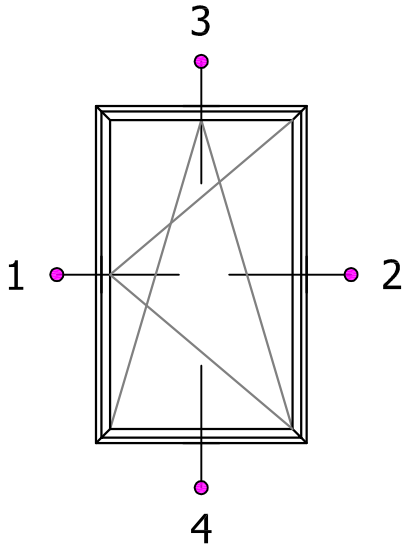

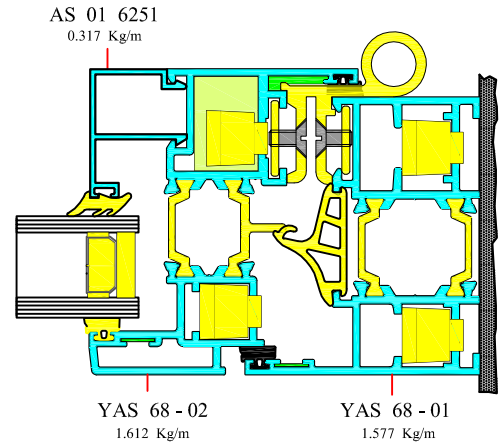
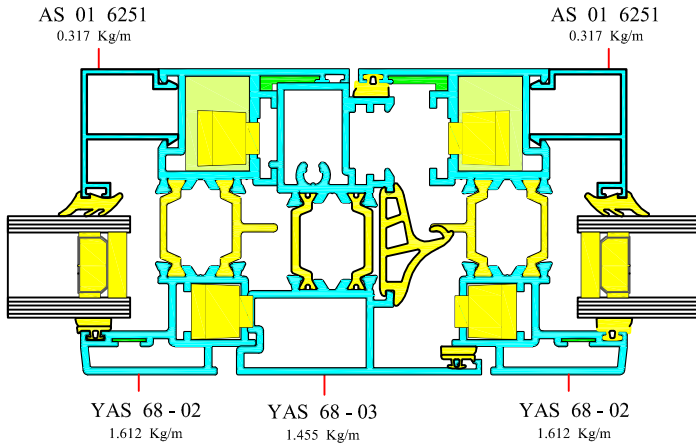
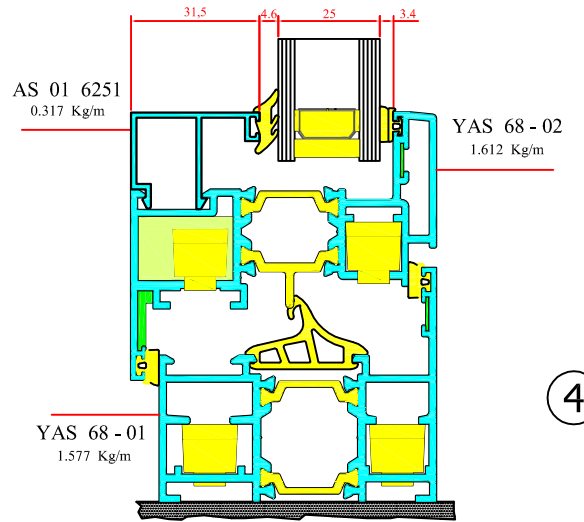
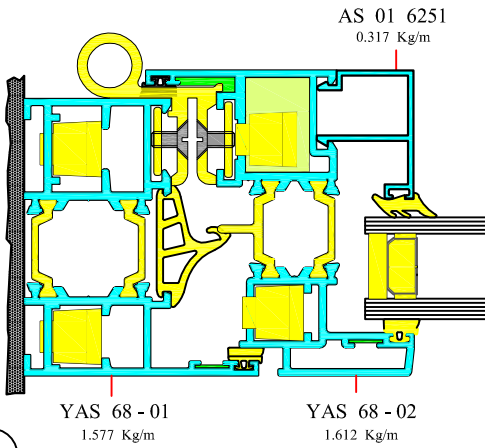
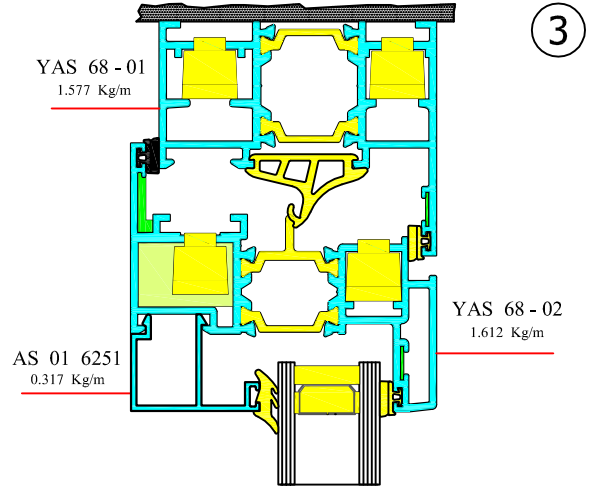
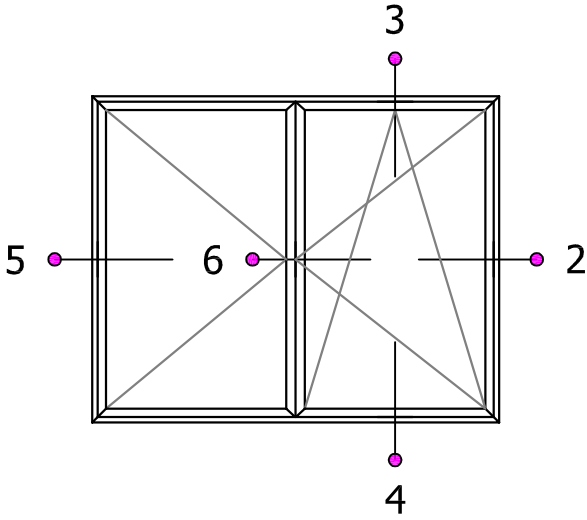

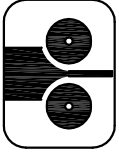

ALÇIN
Alüminyum A.Ş.

YALITIMLI AÇILIR SERİ

AS 01 6251
0.317 Kg/m

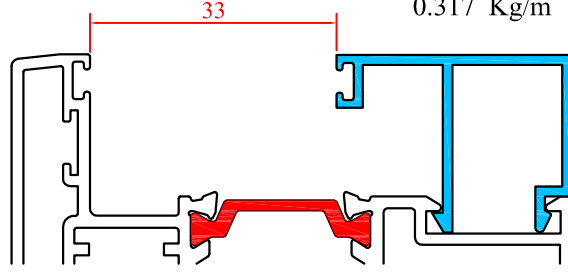

AS 01 6252
0.380 Kg/m

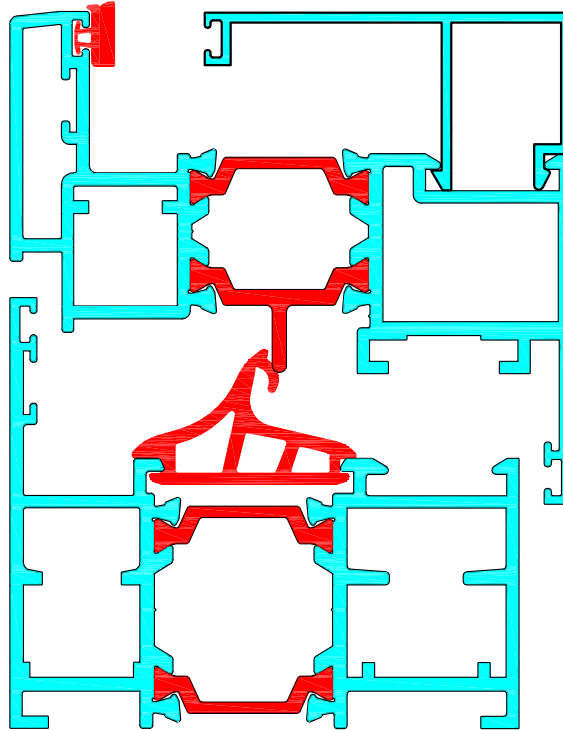

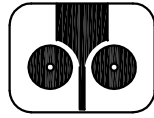

ALÇİN
Alüminyum A.S.

YALITIMLI AÇILIR SERİ

YAS 68 - 07
2.920 Kg/m

ZEMİN EŞİK DETAY 1

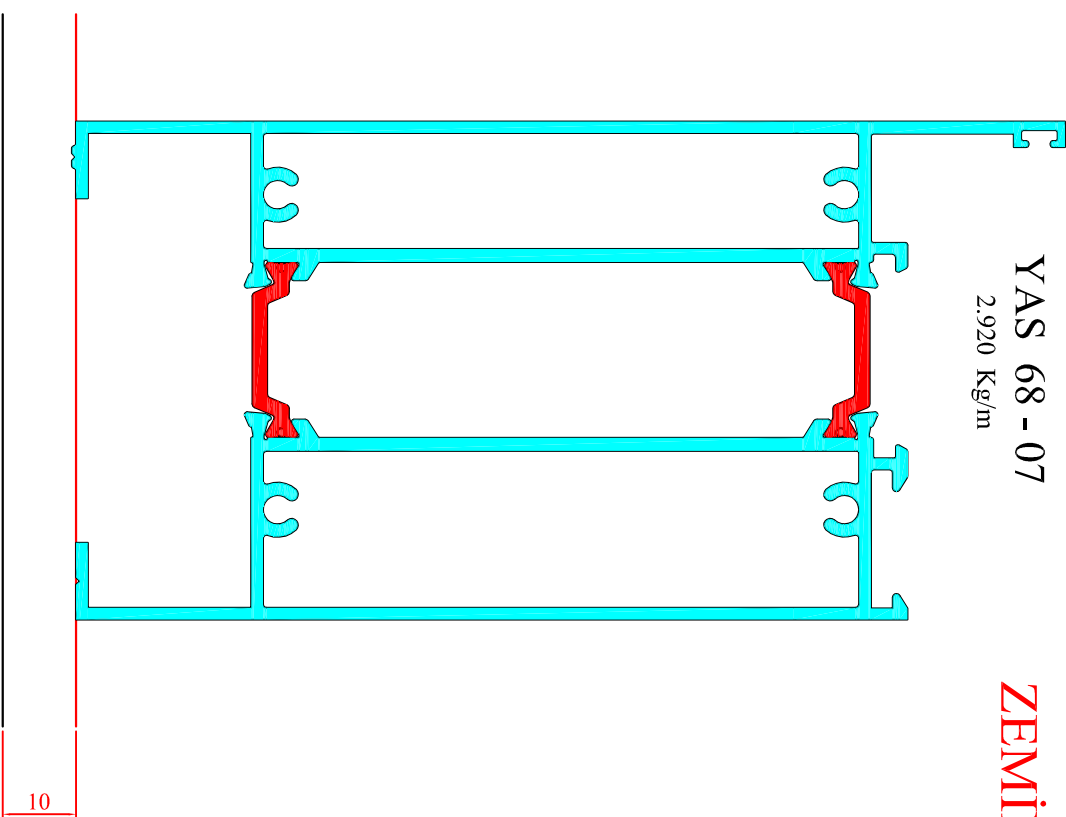

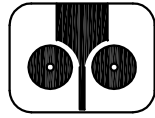

ALÇIN
Alüminyum A.S.

YALITIMLI AÇILIR SERİ

ZEMİN EŞİK DETAY 2

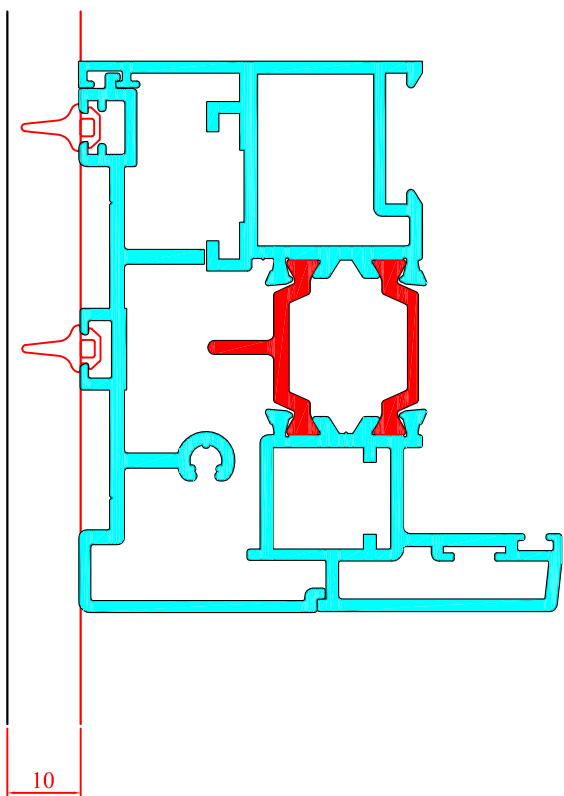



ALÇIN
Alüminyum A.S.

YALITIMLI AÇILIR SERİ

ZEMİN EŞİK DETAY 3

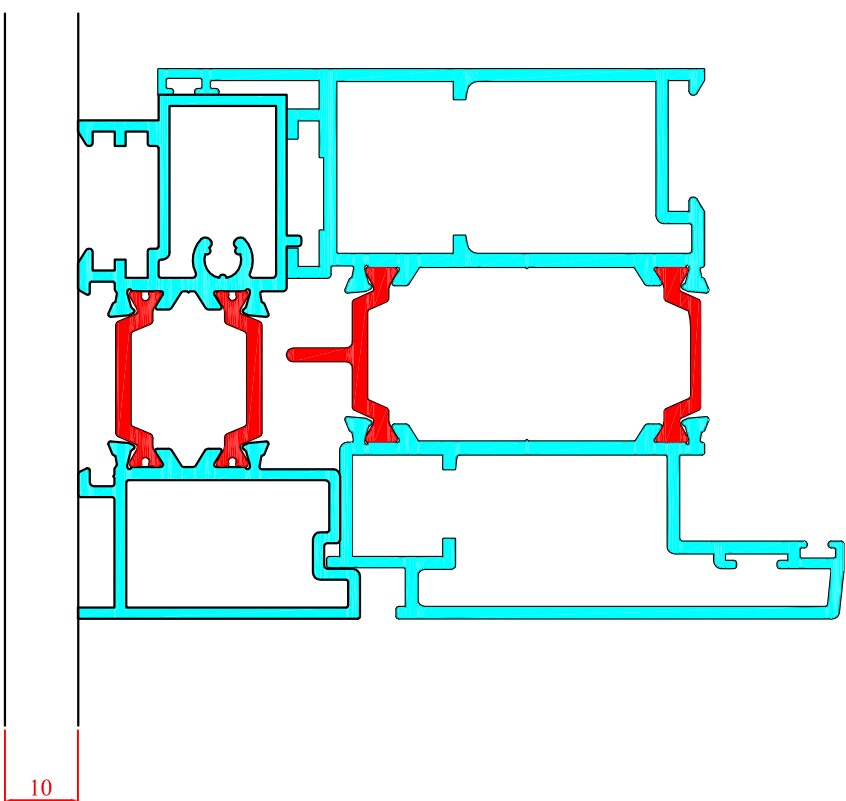

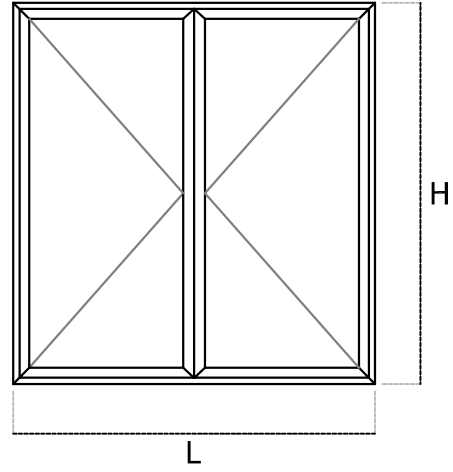
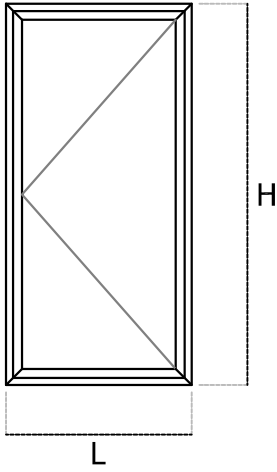
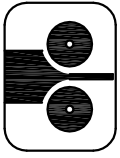

DIMENSIONS IN MILIMETRES

YAS 68 - 01		2	L	
		2	H	
YAS 68 - 02		2	L-60	
		2	H-60	

YAS 68 - 01		2	L	
		2	H	
YAS 68 - 02		4	$\frac{L-65}{2}$	
		4	H-60	
YAS 68 - 03		1	H-000	

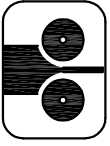

İÇTEN GÖRÜNÜM

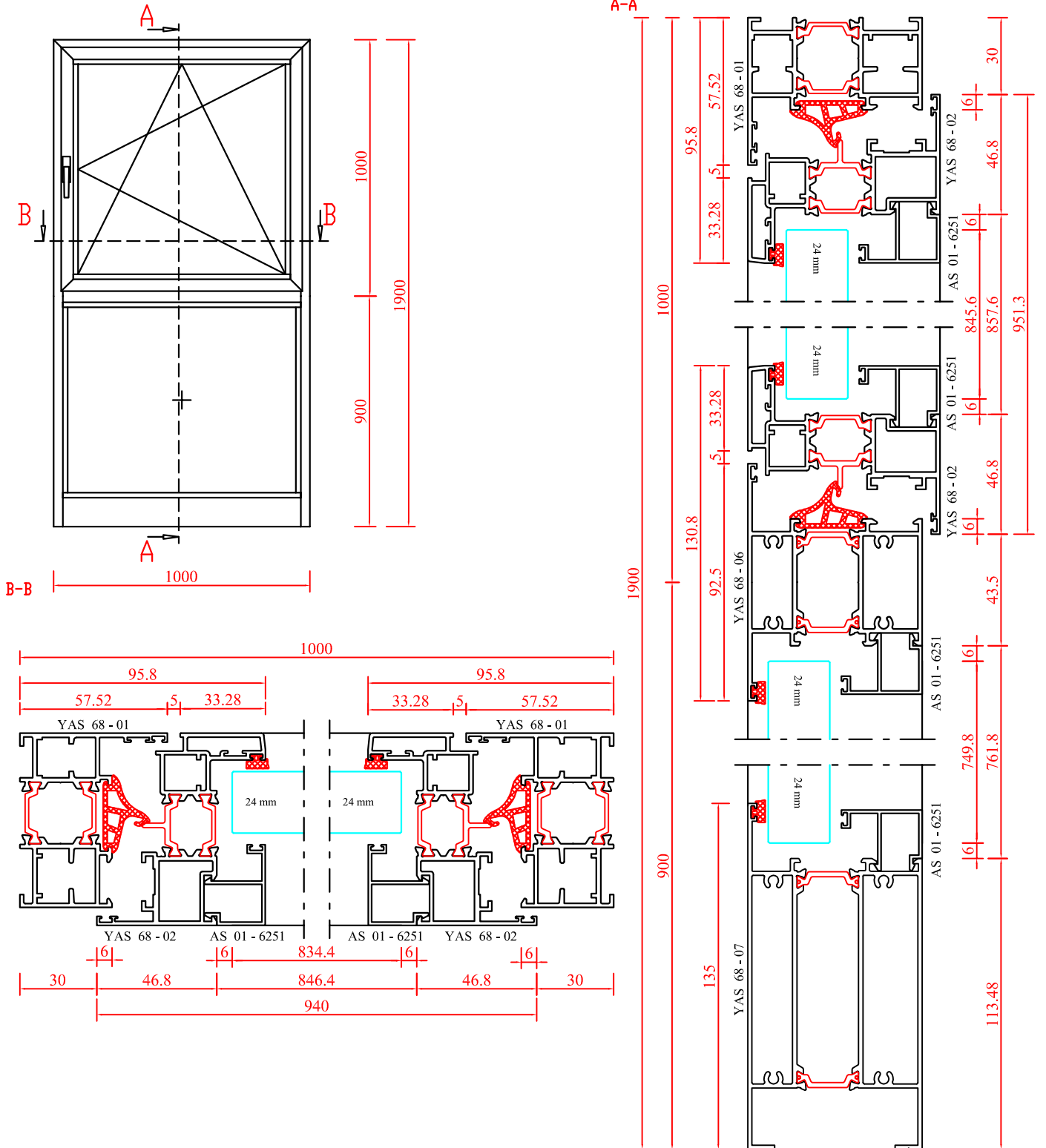

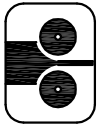

İÇTEN GÖRÜNÜM

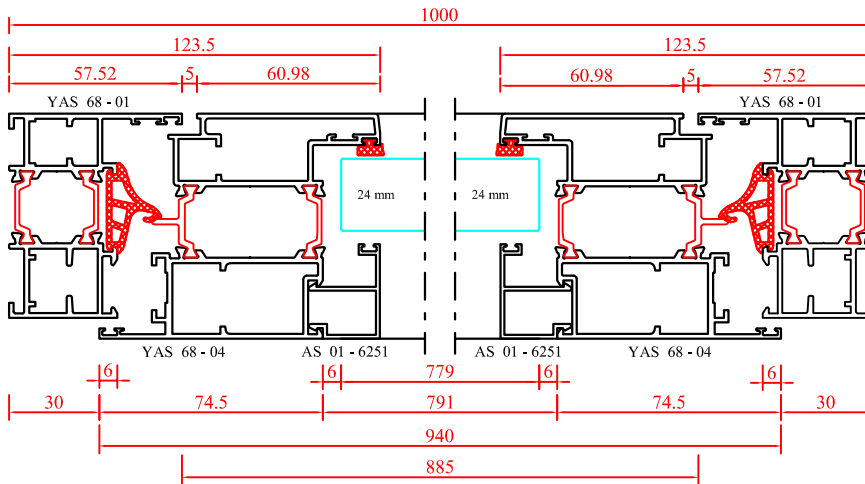
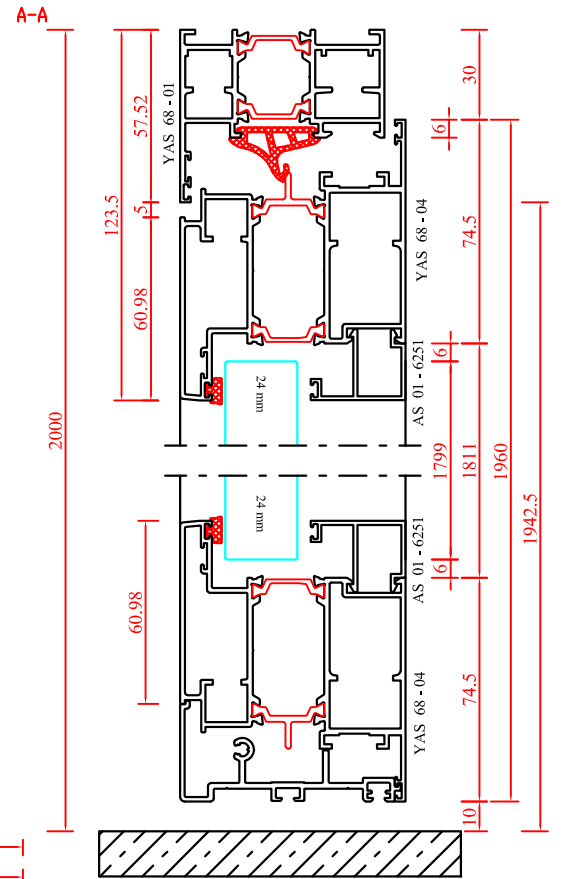
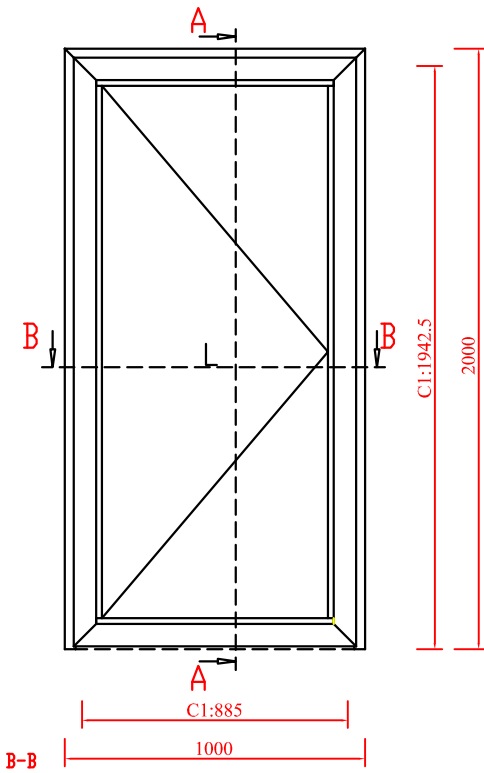



ALÇIN
Alüminyum A.S.

YALITIMLI AÇILIR SERİ

İÇTEN GÖRÜNÜM

