

1510

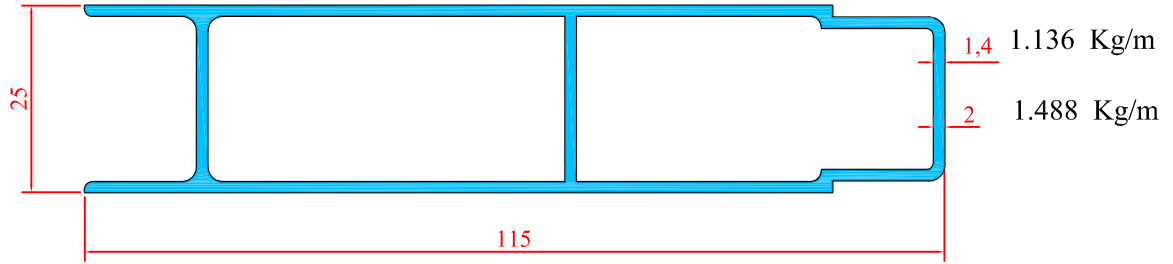

1568

0.664 Kg/m

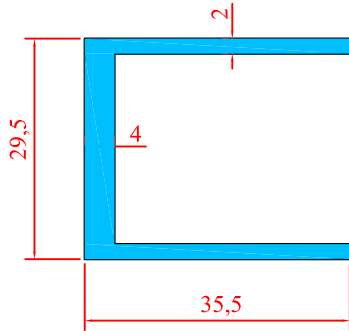

1569

1.035 Kg/m

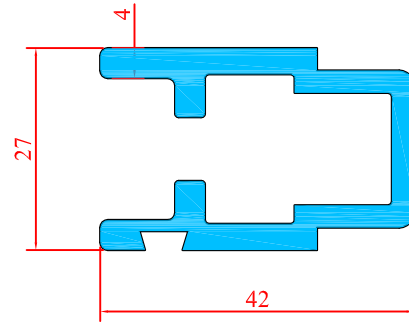

1570

1.602 Kg/m

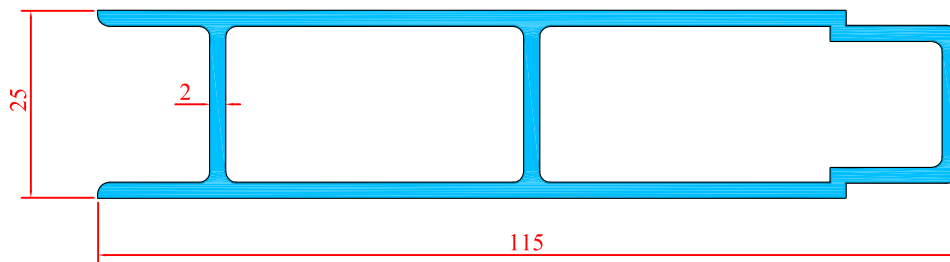

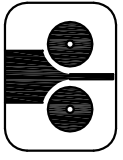

1571

1.158 Kg/m

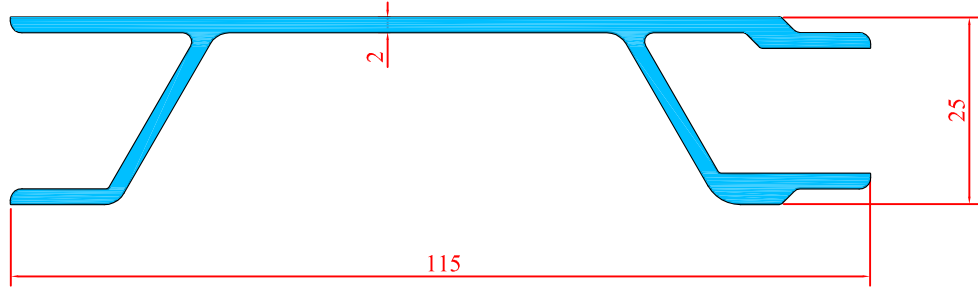

1572

0.426 Kg/m

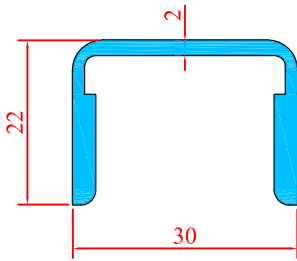

1573

1.097 Kg/m

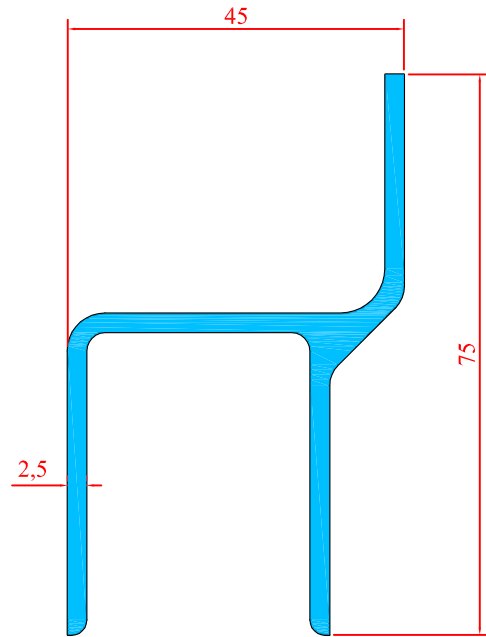

1574

1.893 Kg/m

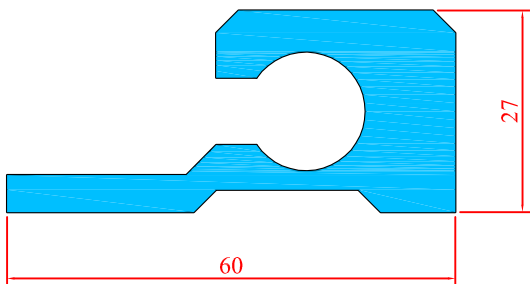

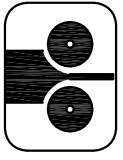

1575

1.973 Kg/m

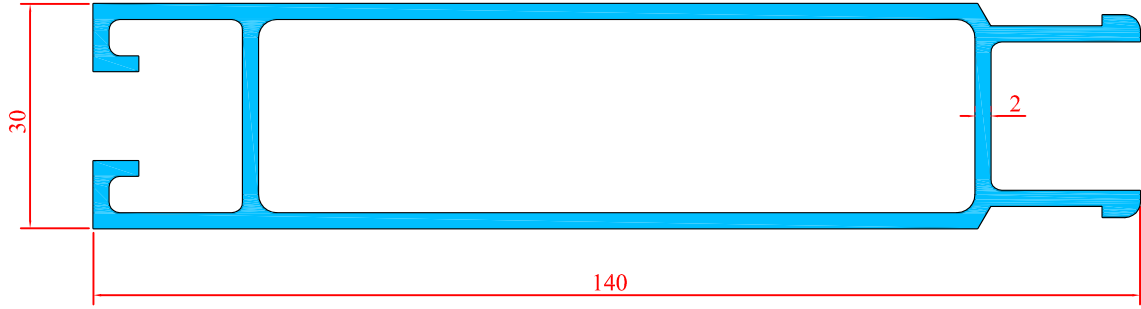

1576

1.908 Kg/m

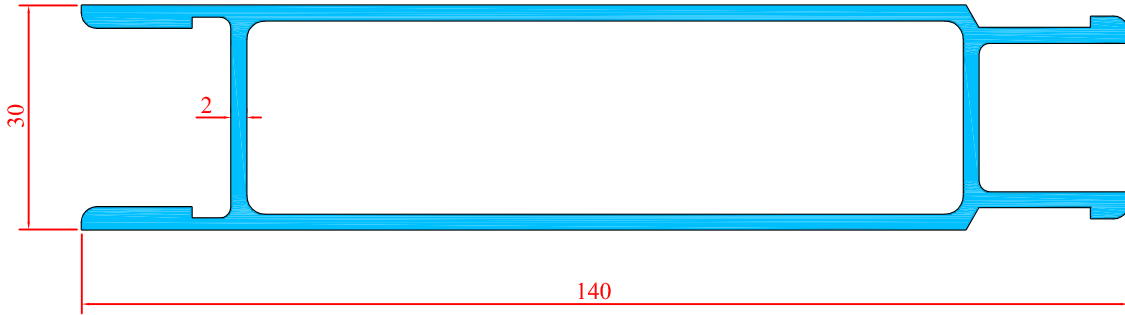

1577

2.150 Kg/m

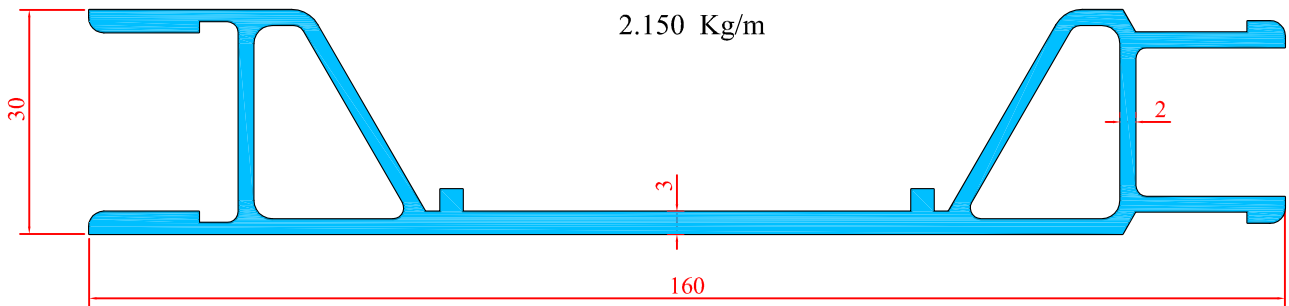

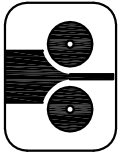

1578

2.716 Kg/m

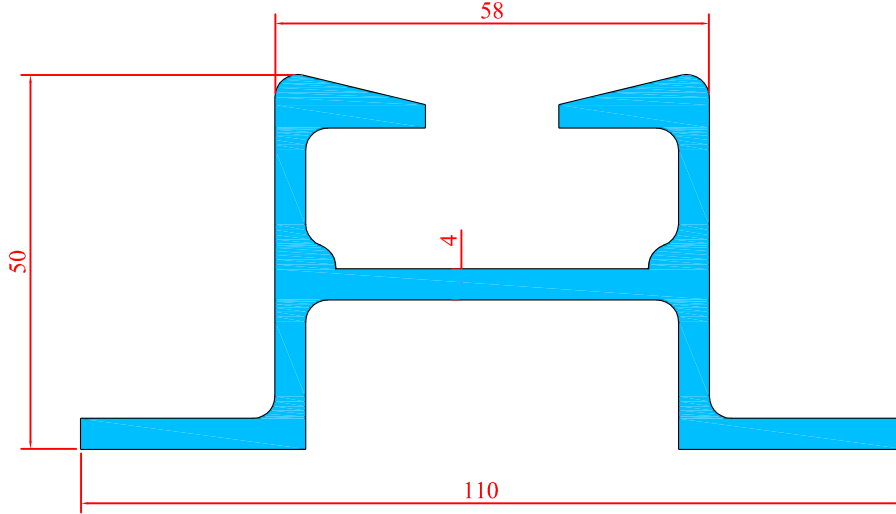

1579

0.315 Kg/m

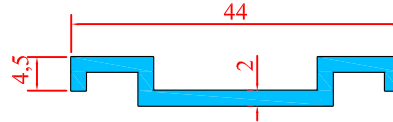

1580

1.587 Kg/m

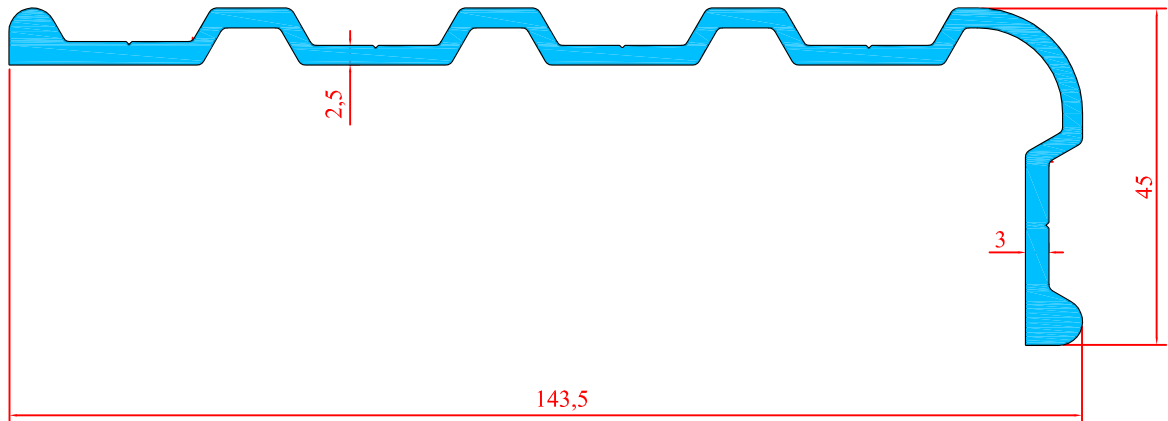

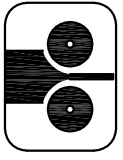

1581

2.105 Kg/m

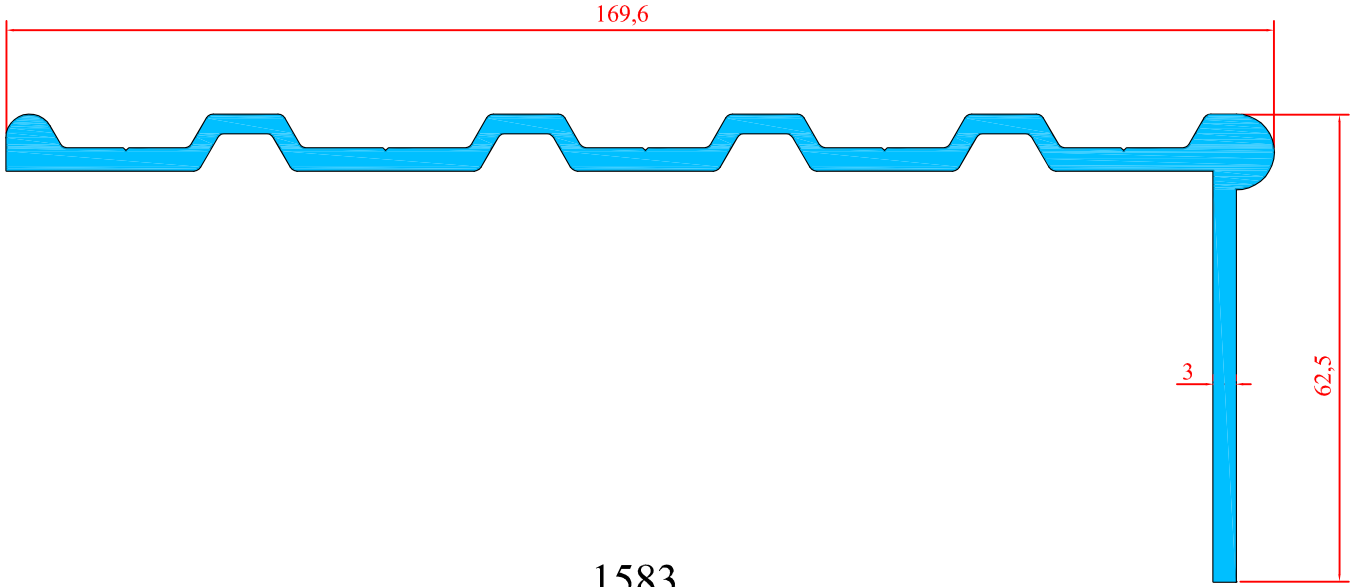

1583

1.847 Kg/m

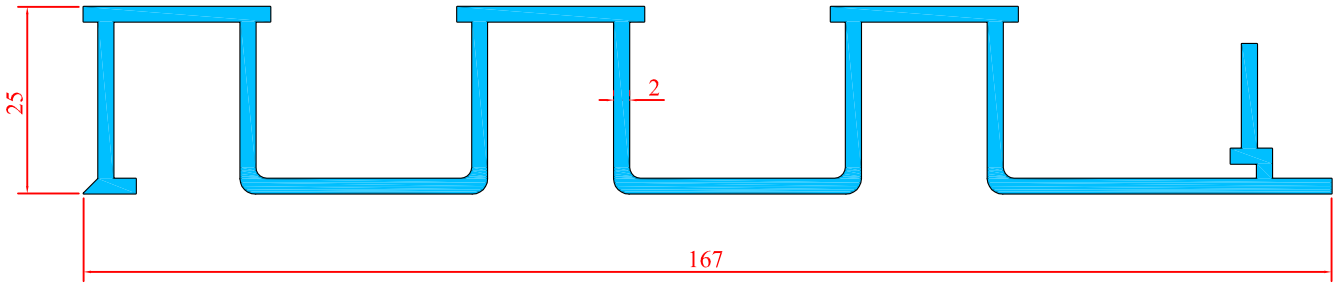

1643

2.198 Kg/m

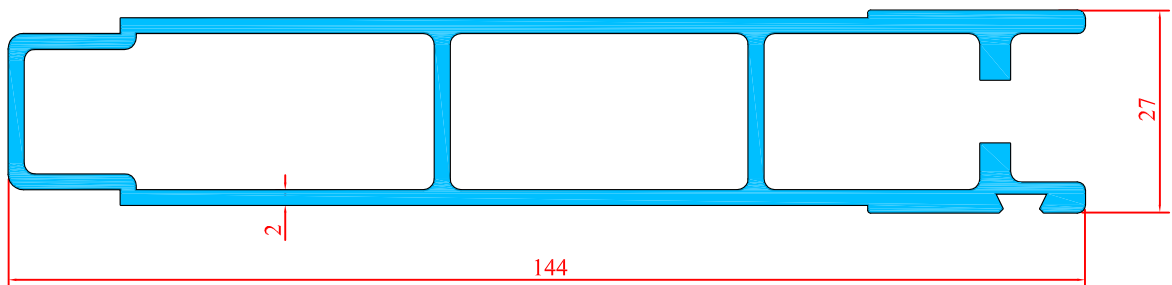

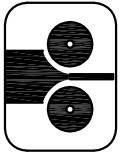

1645
2.396 Kg/m

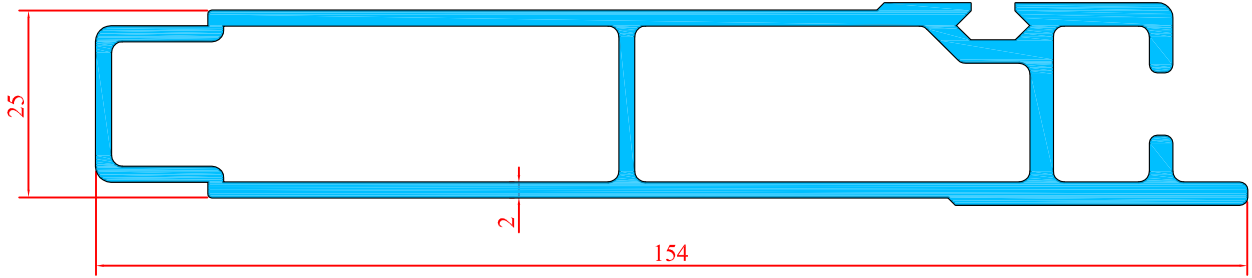

1647
1.748 Kg/m

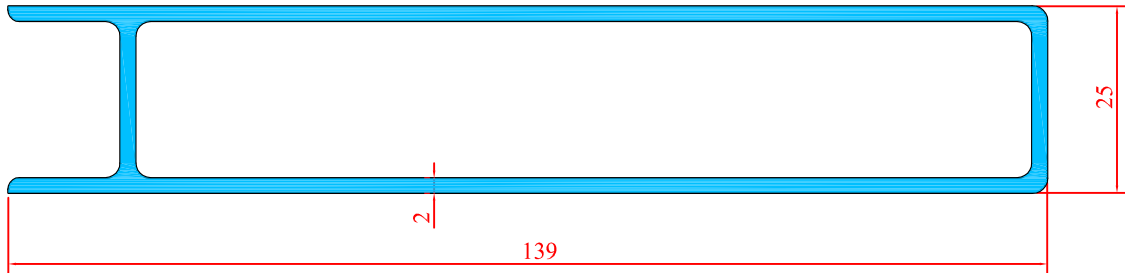

96,5

1679
1.470 Kg/m

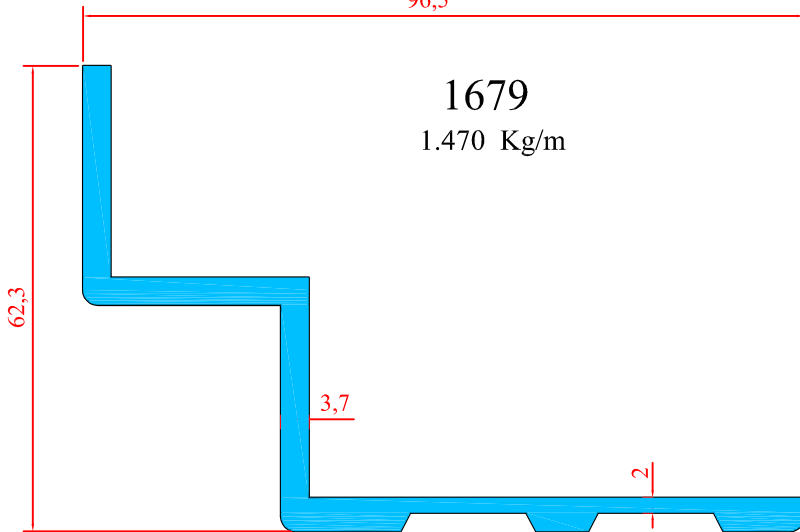

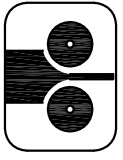

3234

1.080 Kg/m

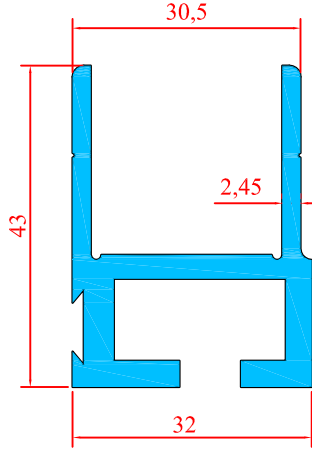

1680

0.705 Kg/m

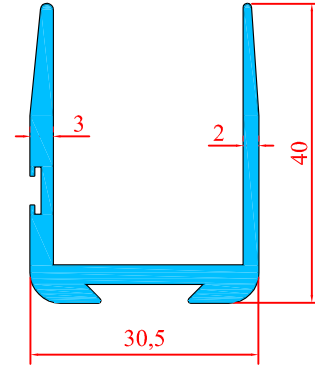

3236

0.755 Kg/m

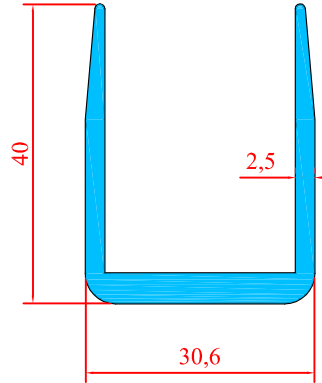

1681

0.910 Kg/m

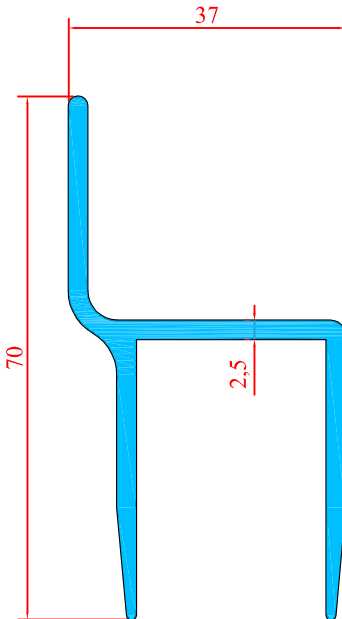

3235

1.462 Kg/m

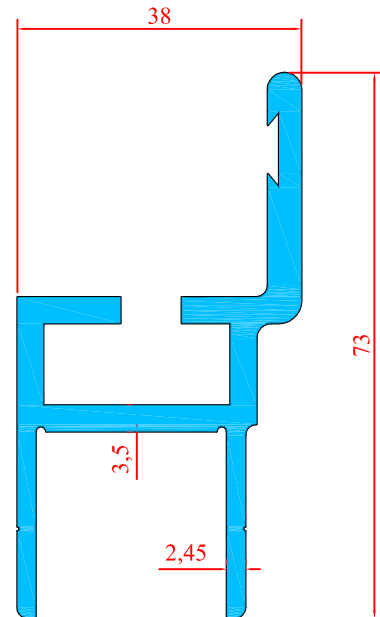

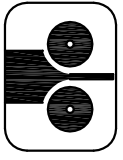

3237

1.297 Kg/m

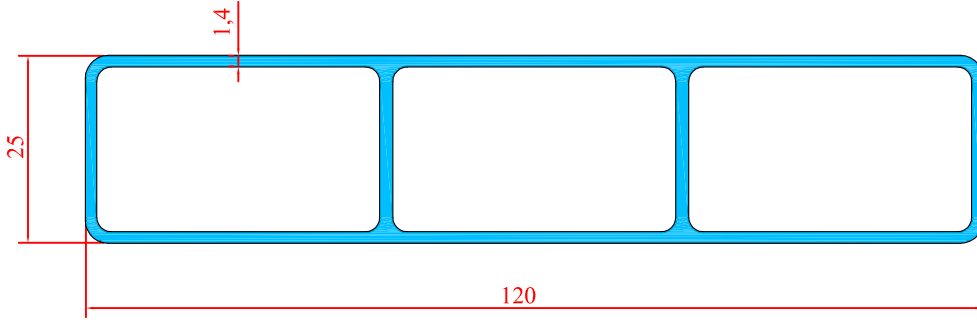

3238

1.597 Kg/m

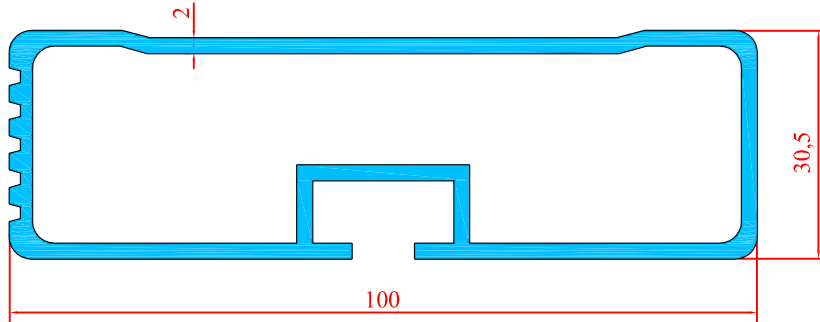



ALÇİN
Alüminyum A.Ş.

TIR PROFİLLERİ

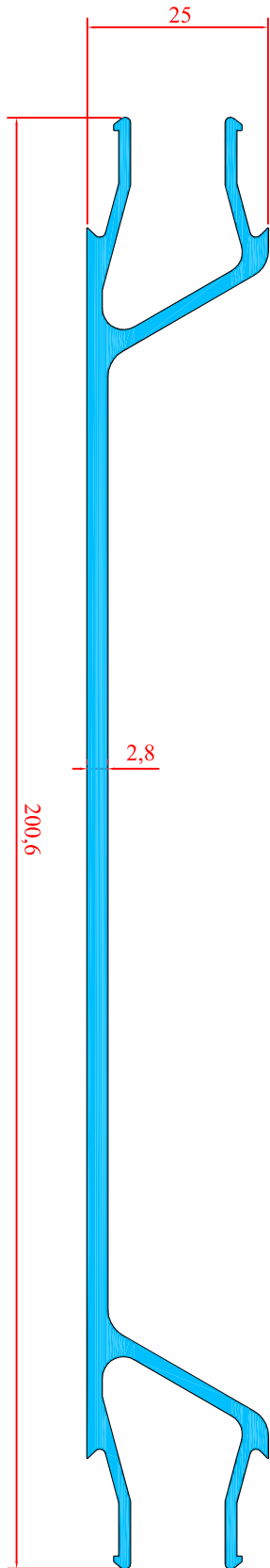

3239

1.930 Kg/m

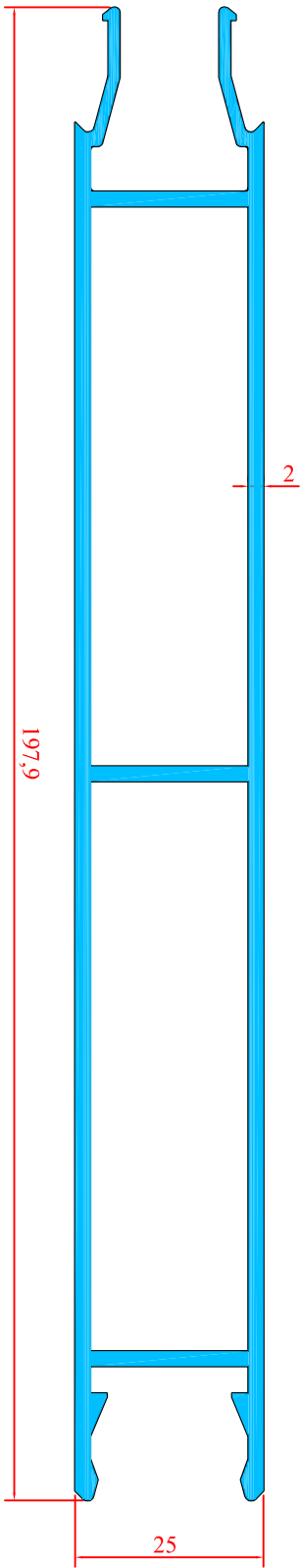

3240

2.555 Kg/m



ALÇİN
Alüminyum A.Ş.

TIR PROFİLLERİ

3241

2.297 Kg/m

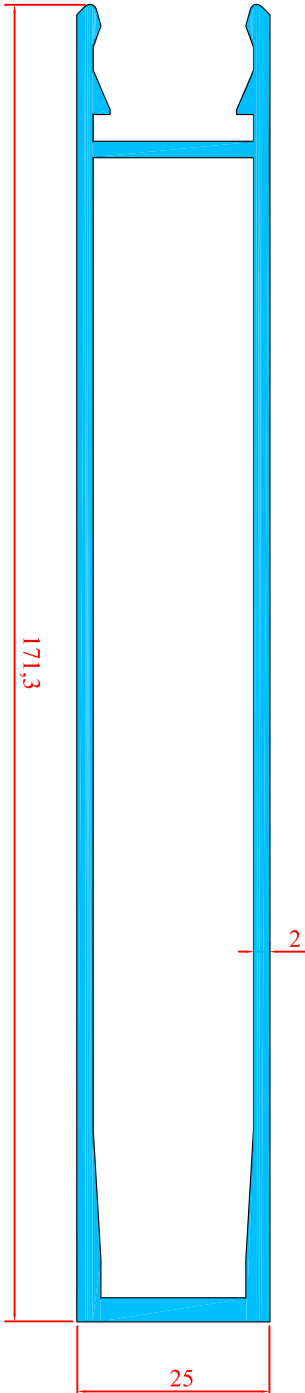

3242

2.767 Kg/m

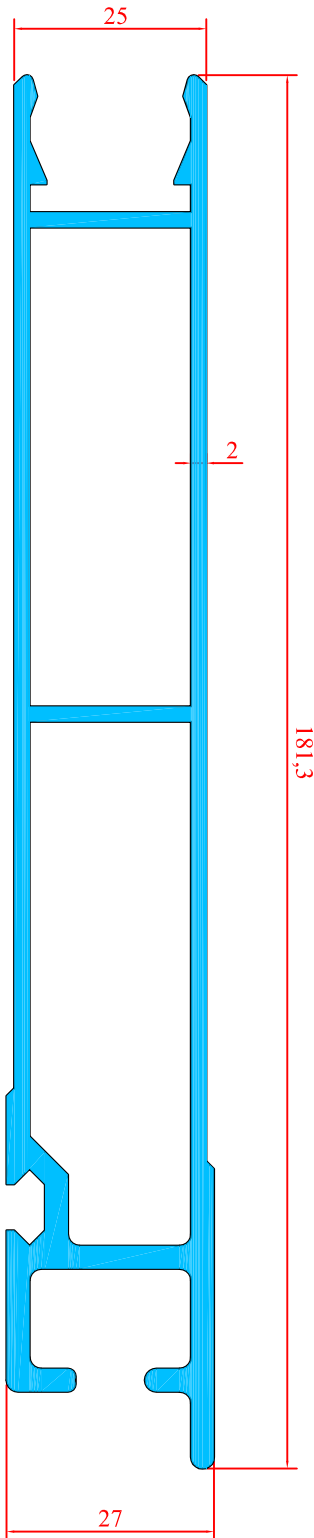

135



ALÇİN
Alüminyum A.Ş.

TIR PROFİLLERİ

3248

2.640 Kg/m

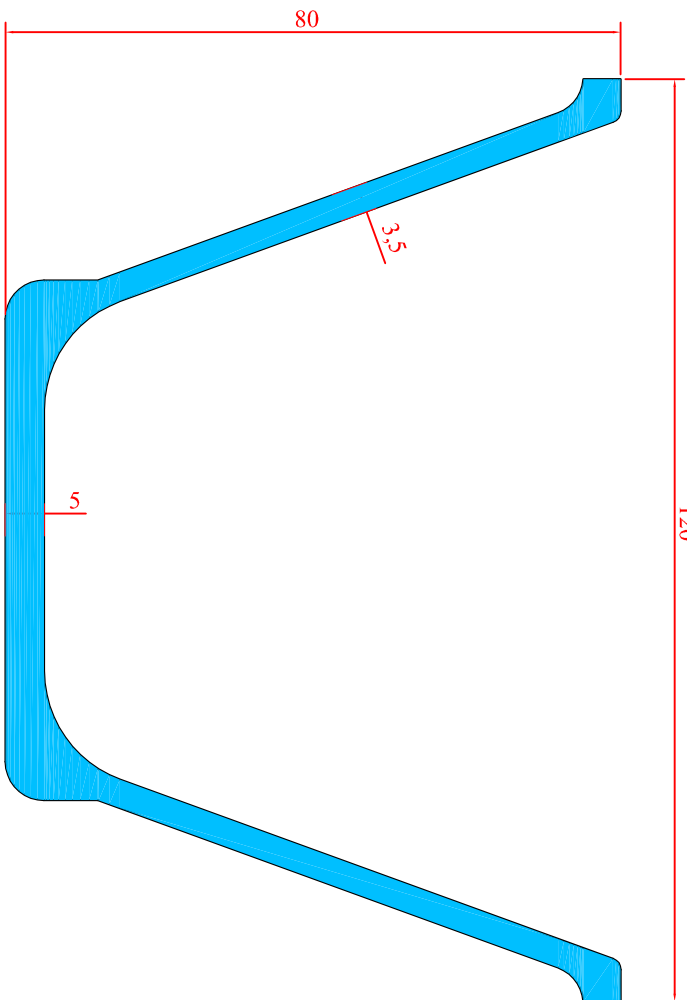



ALÇIN
Alüminyum A.Ş.

TIR PROFİLLERİ

3249

13.332 Kg/m

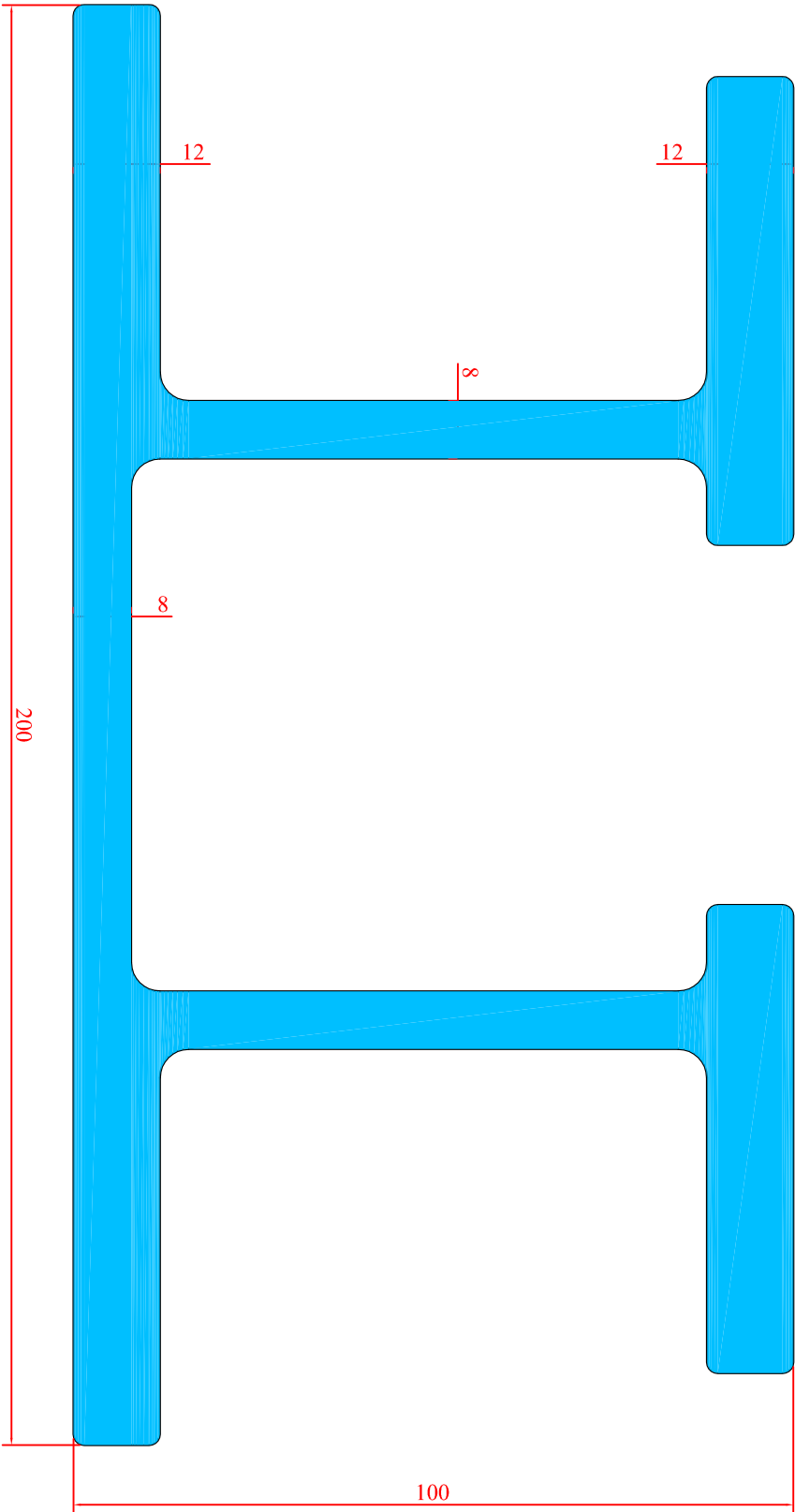



ALÇİN
Alüminyum A.Ş.

TIR PROFİLLERİ

3250

5.510 Kg/m

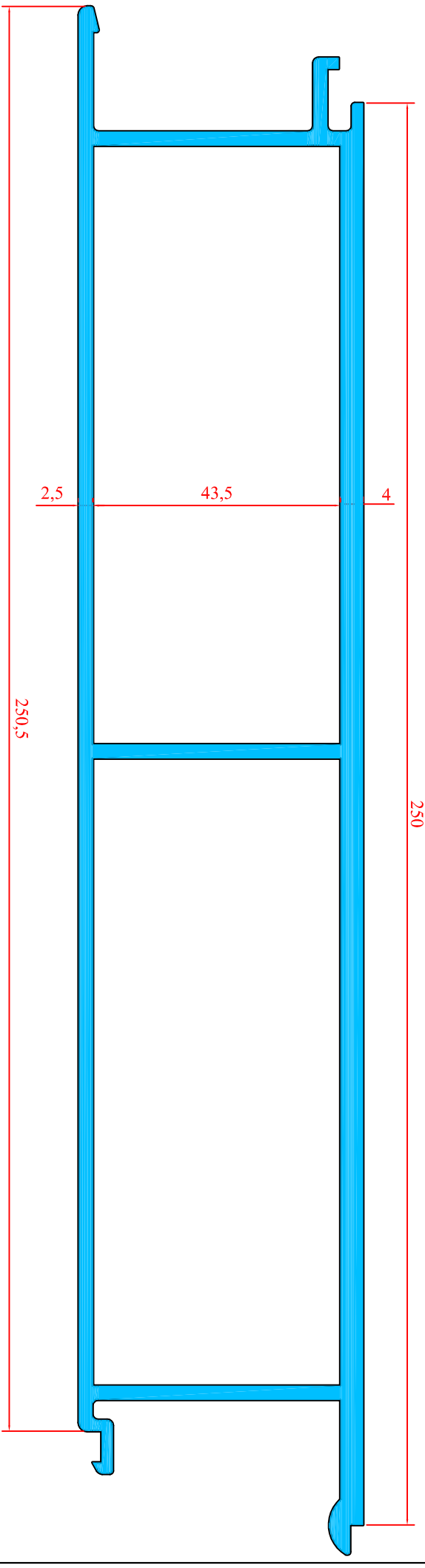



ALÇİN
Alüminyum A.Ş.

TIR PROFİLLERİ

3251

7.122 Kg/m

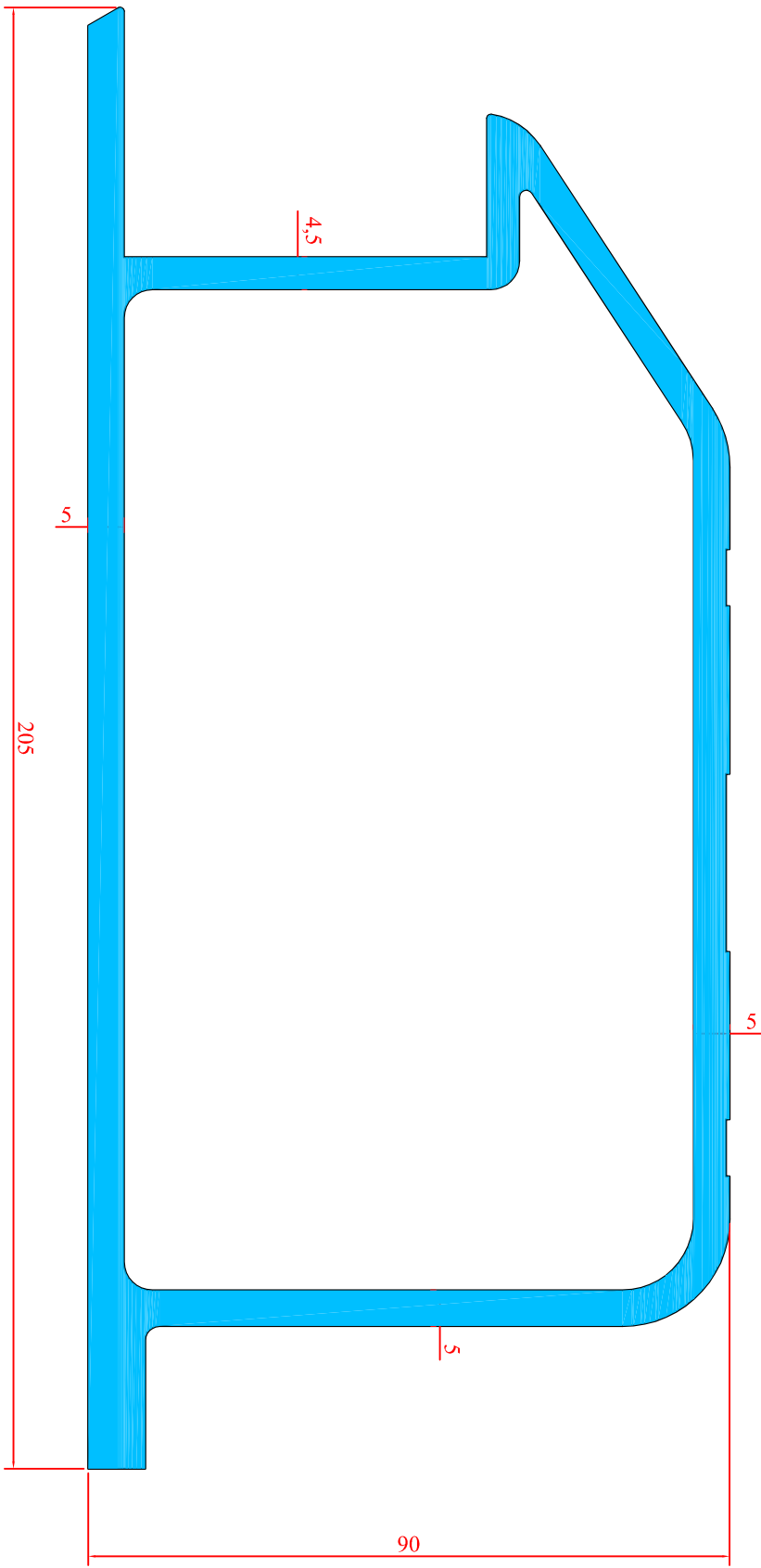



ALÇIN
Alüminyum A.Ş.

TIR PROFİLLERİ

3252

6.886 Kg/m

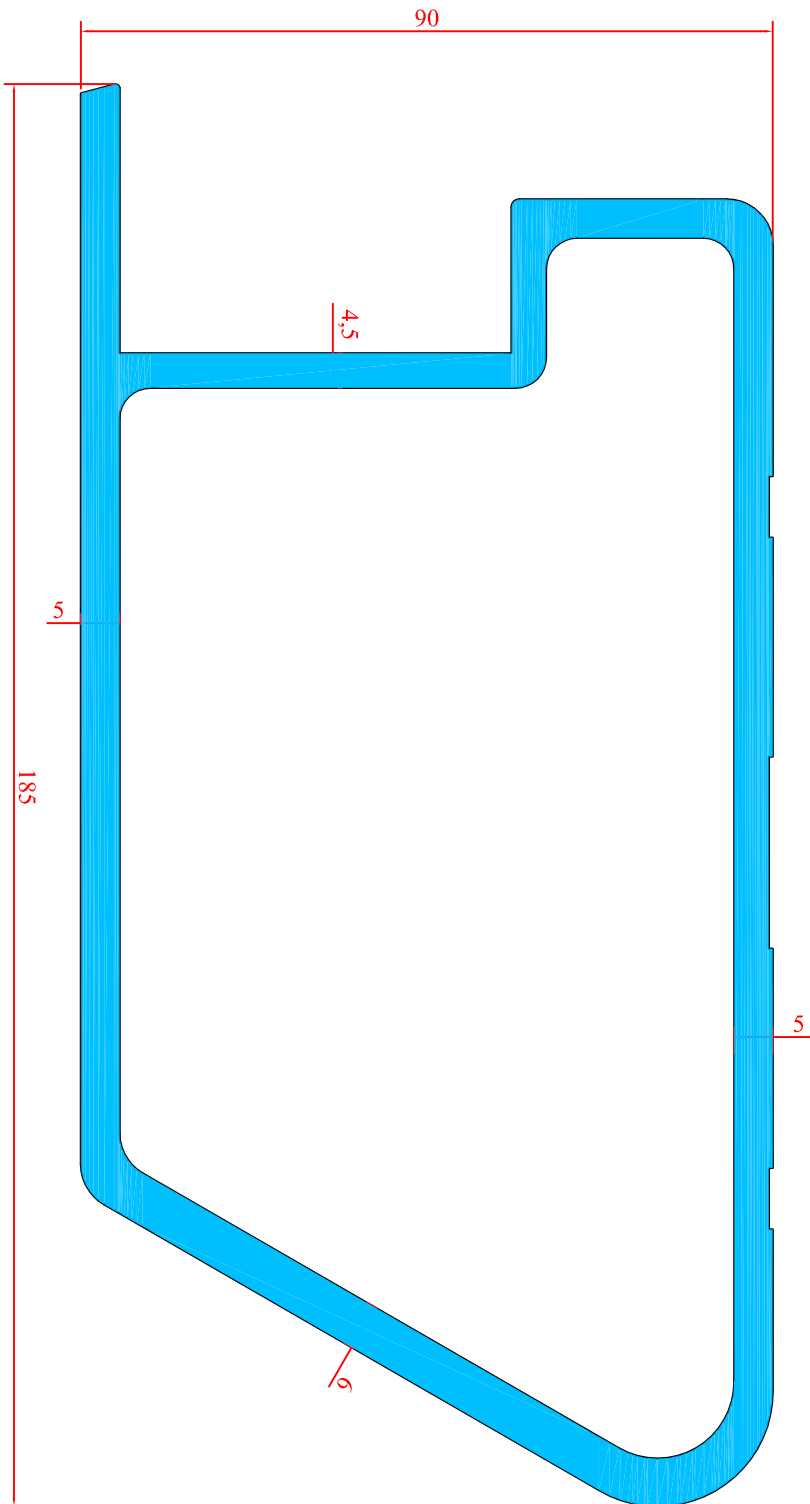

140

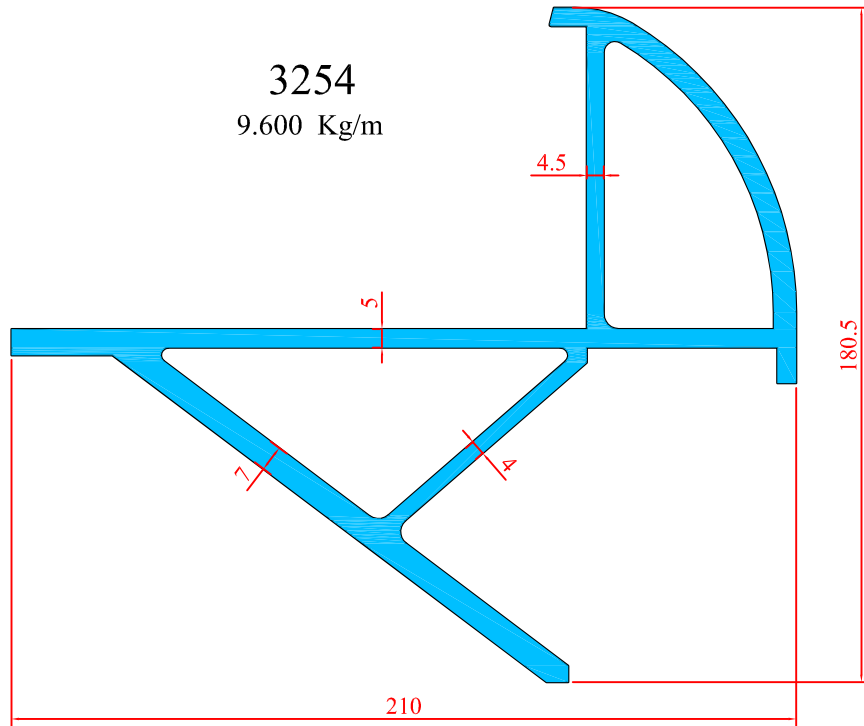
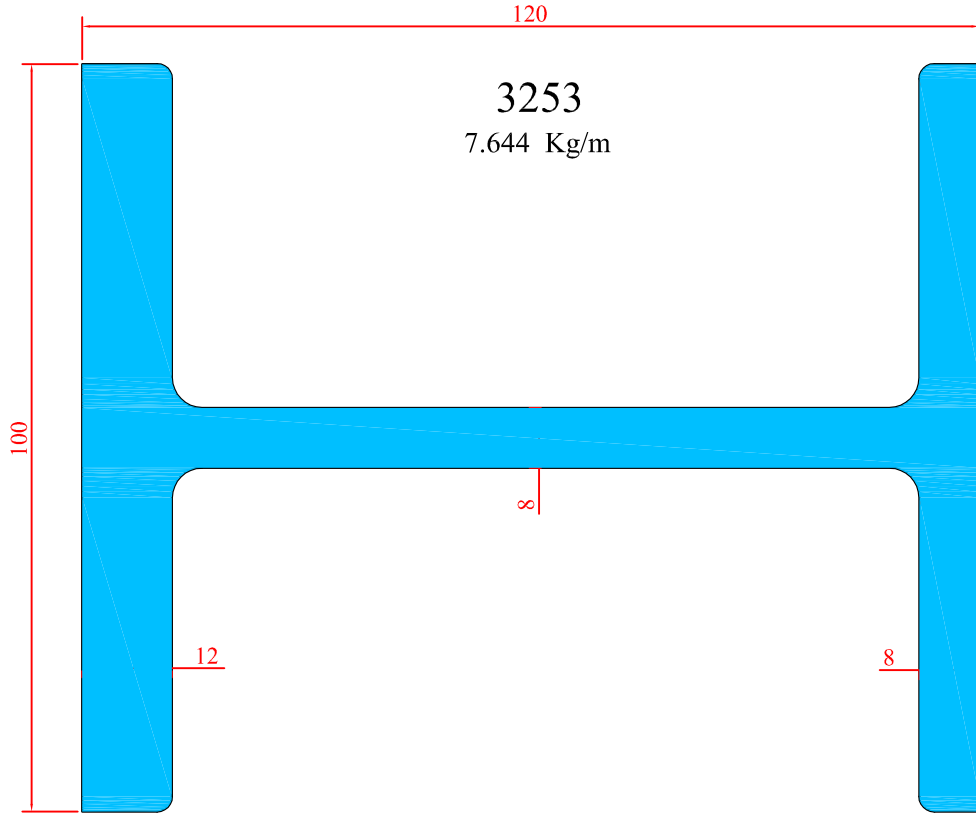
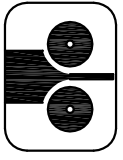



ALÇIN
Alüminyum A.Ş.

TIR PROFİLLERİ

3256

2.783 Kg/m

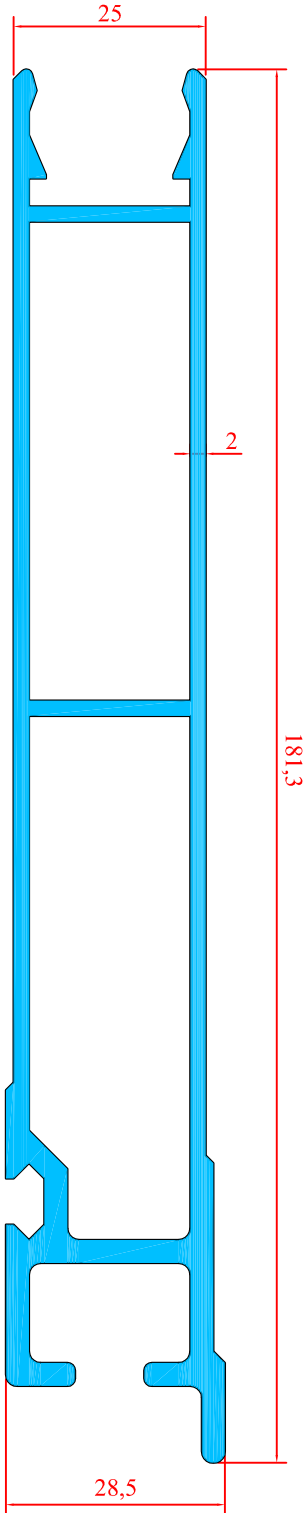

3255

1.727 Kg/m

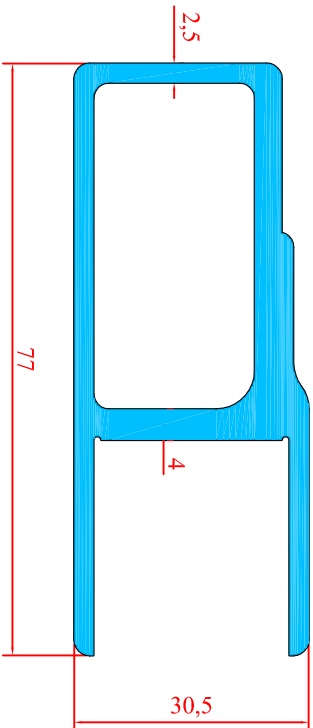



ALÇIN
Alüminyum A.Ş.

TIR PROFİLLERİ

3257

2.685 Kg/m

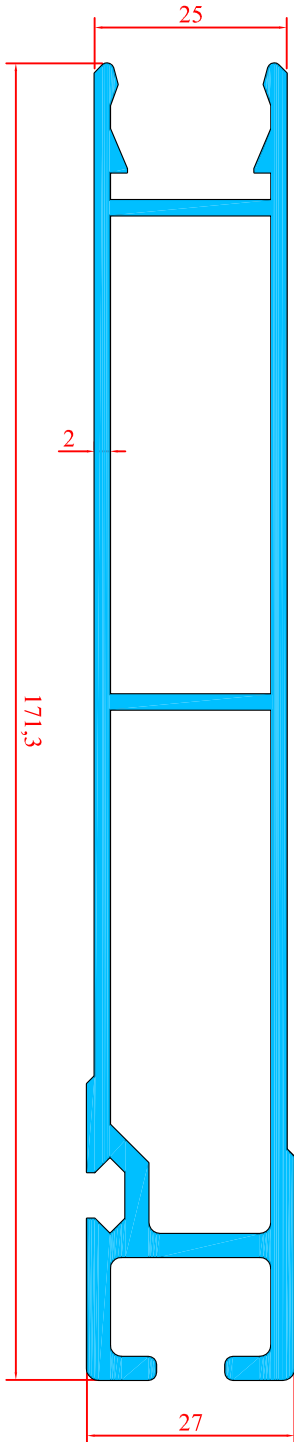

3265

1.823 Kg/m

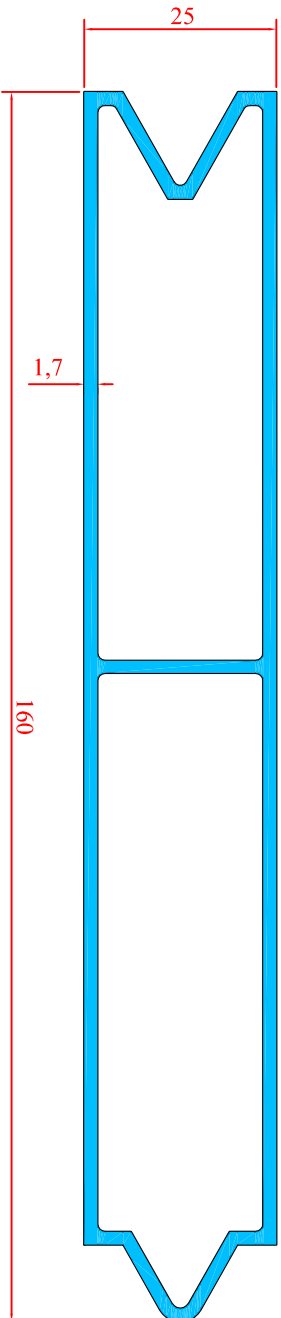

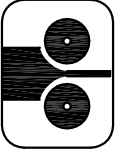

3260

1.790 Kg/m

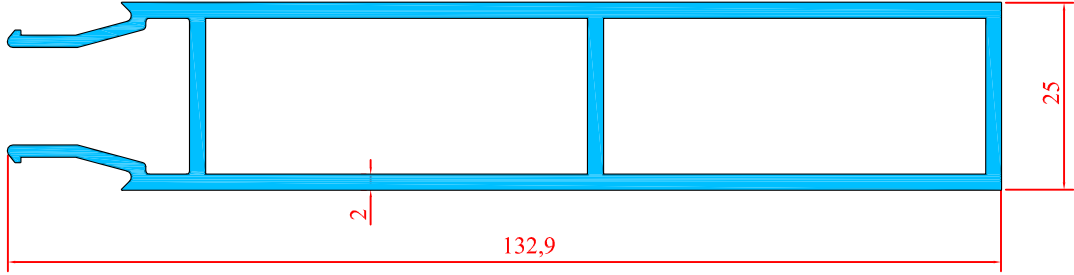

3261

3.473 Kg/m

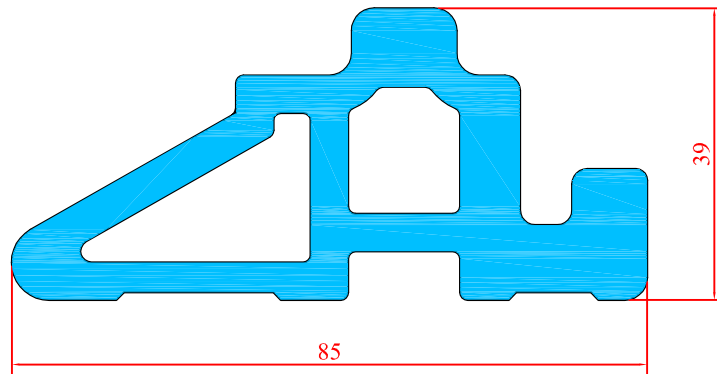



ALÇIN
Alüminyum A.Ş.

TIR PROFİLLERİ

3266

2.631 Kg/m

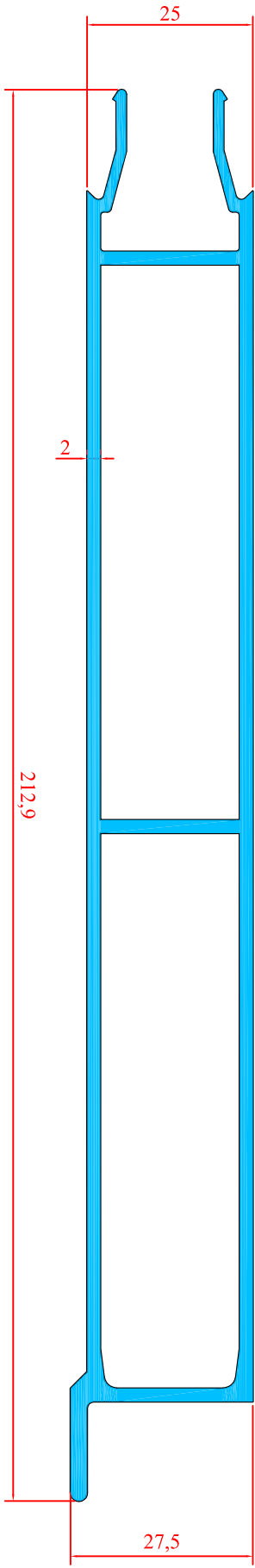

3267

1.859 Kg/m

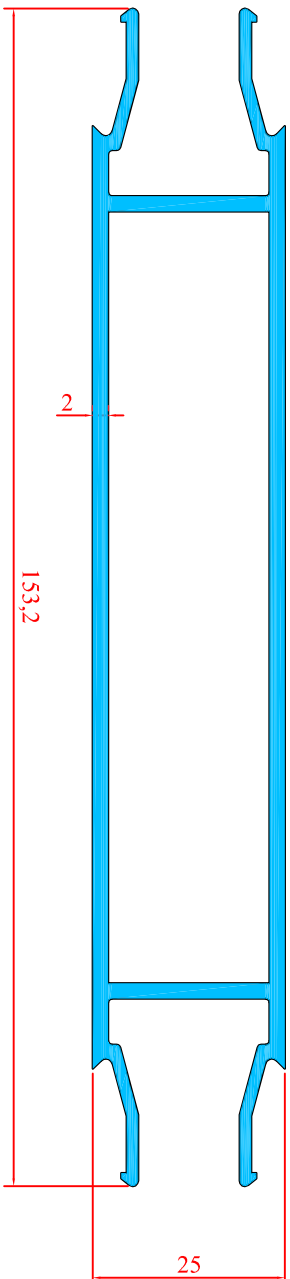

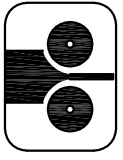

3268
1.920 Kg/m

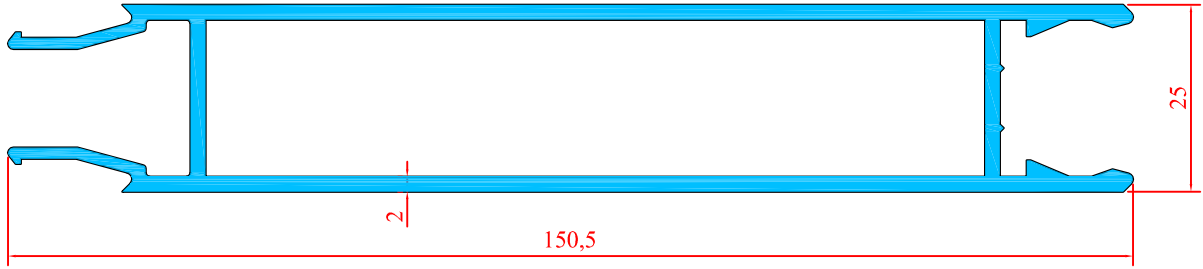

3269
0.862 Kg/m

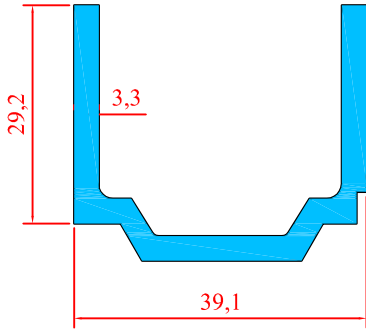

3270
0.642 Kg/m

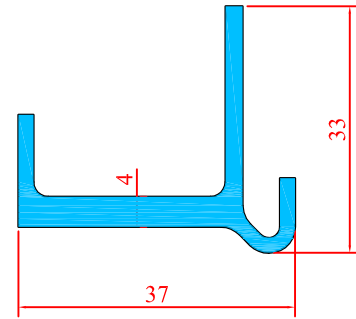

3271
0.645 Kg/m

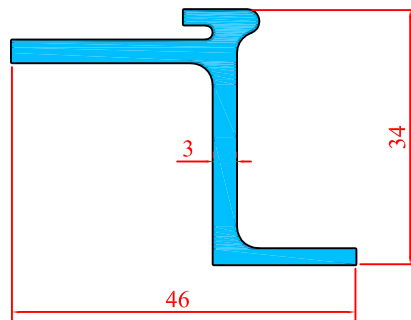

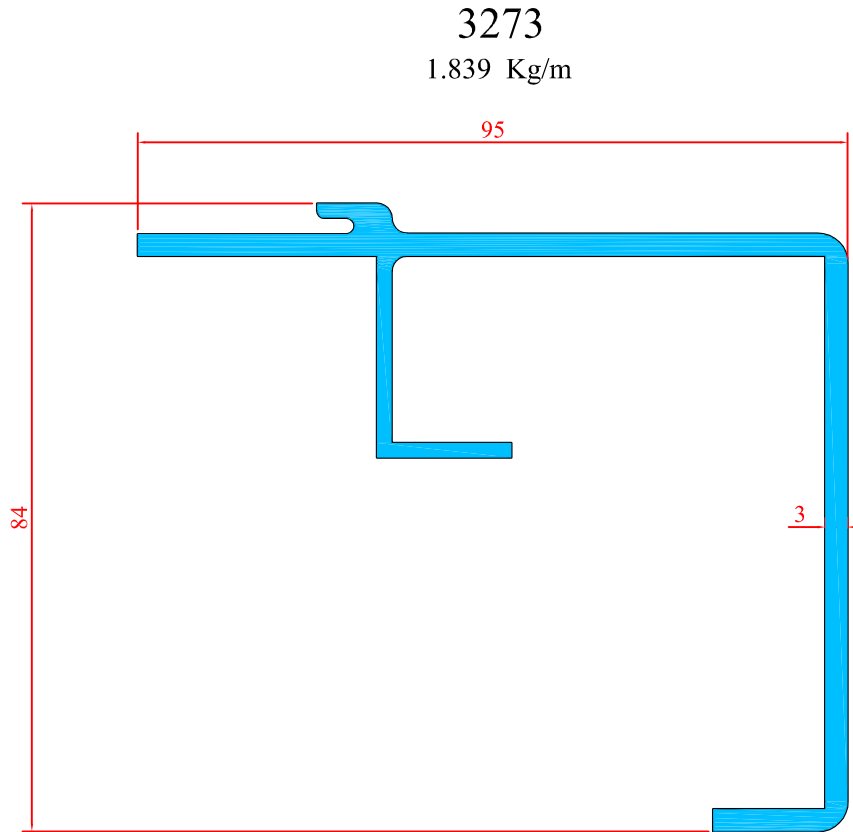
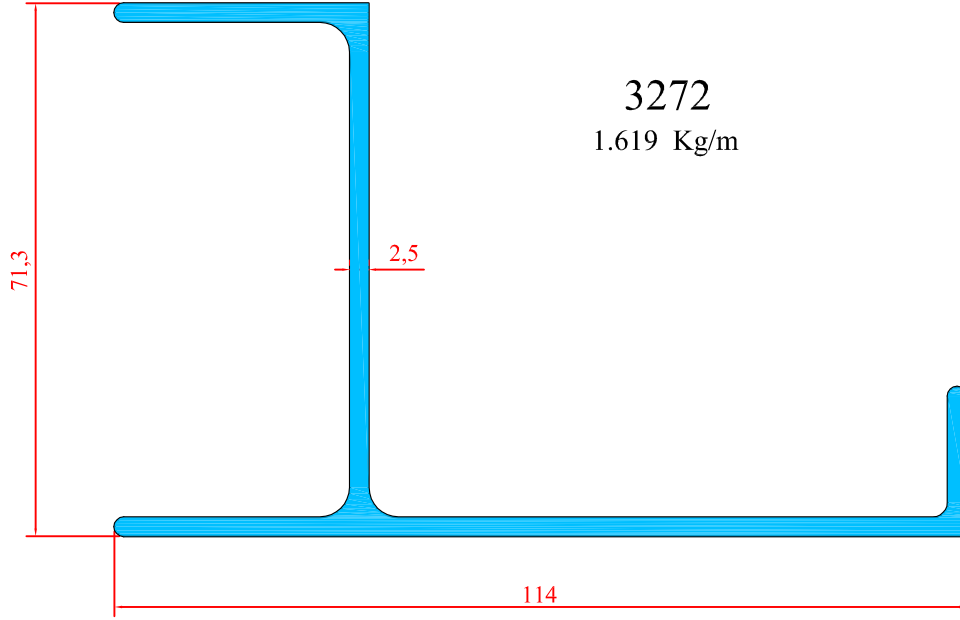
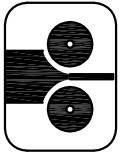

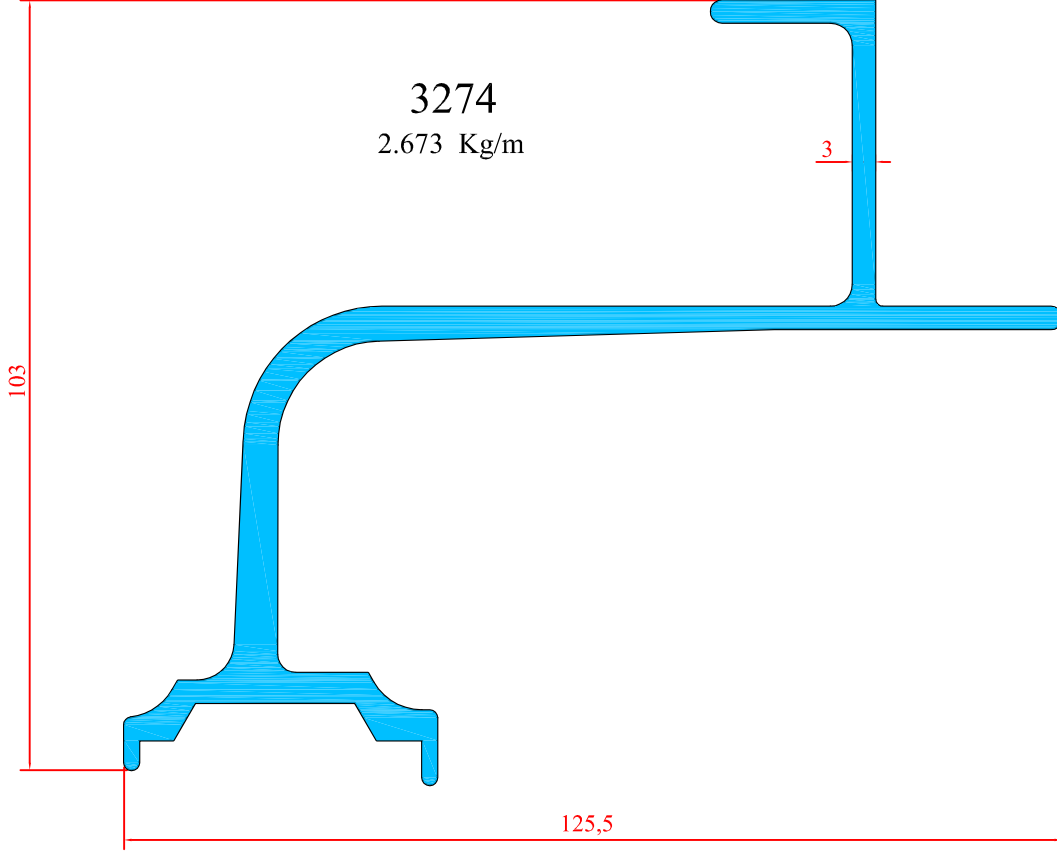
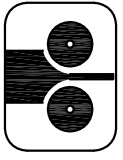

3325
0.479 Kg/m

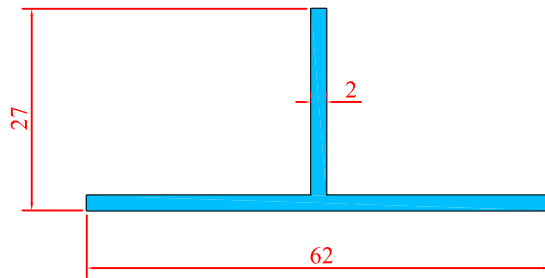



ALÇİN
Alüminyum A.Ş.

TIR PROFİLLERİ

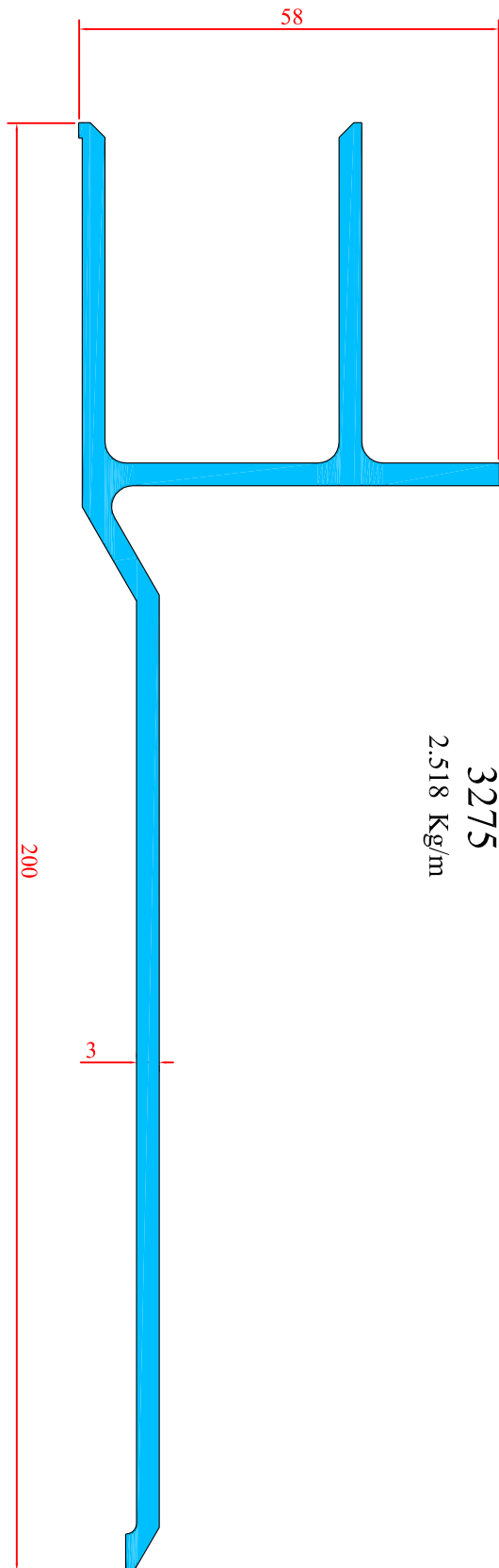

3275

2.518 Kg/m

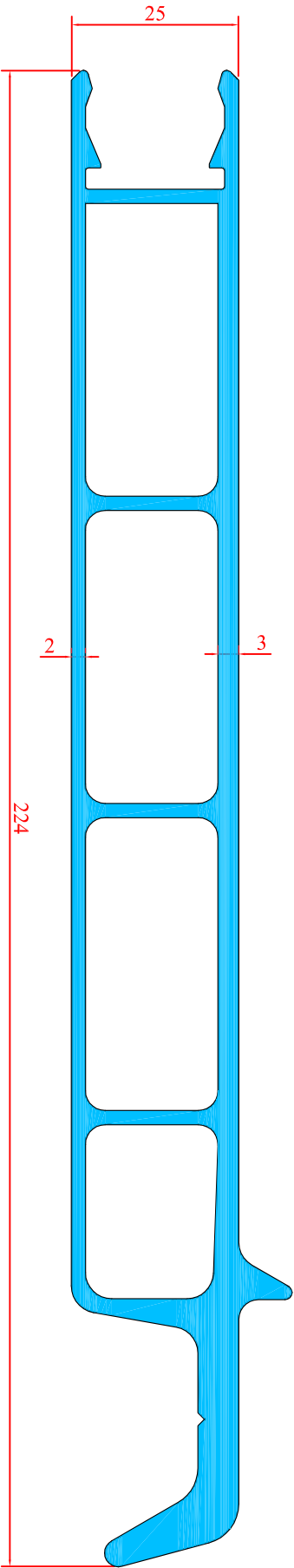

3326

4.140 Kg/m

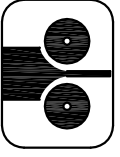

3328
1.048 Kg/m

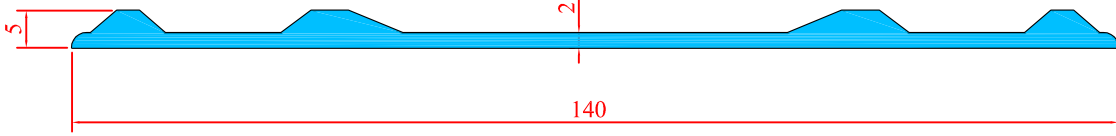

3329
2.130 Kg/m

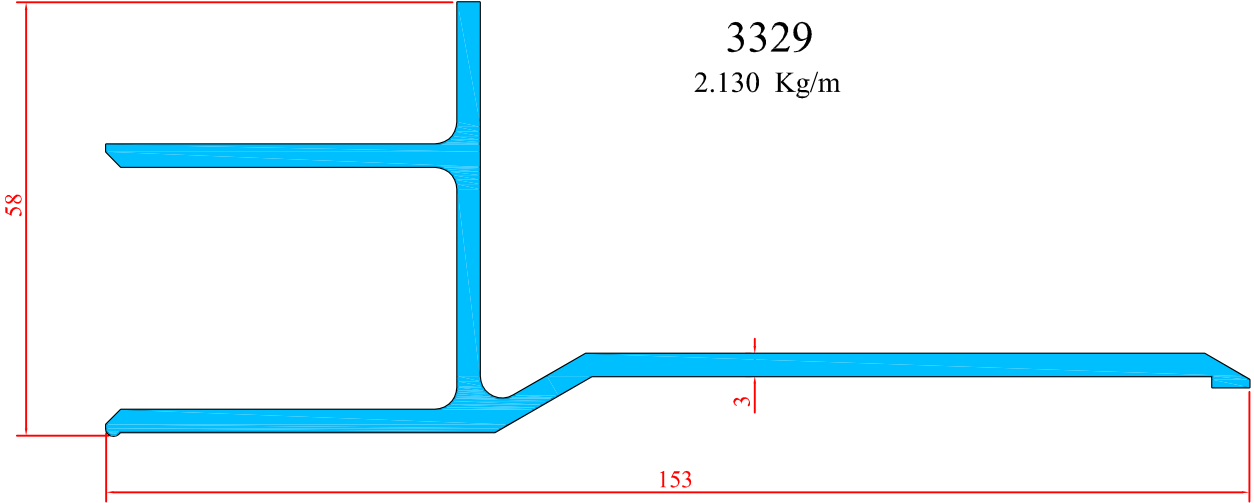

3345
1.297 Kg/m

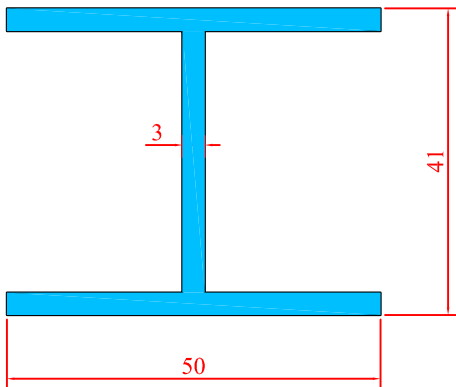

3327
0.180 Kg/m

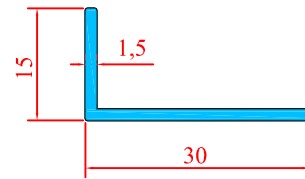

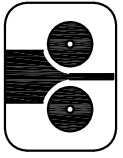

3346
0.591 Kg/m

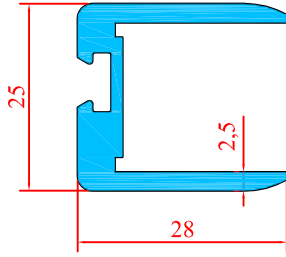

3347
0.830 Kg/m

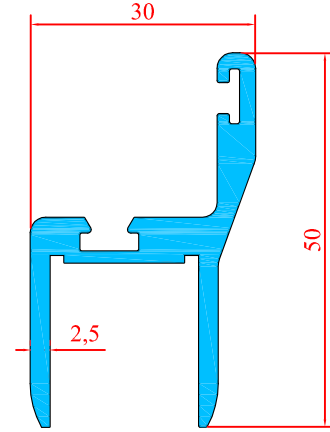

3380
1.405 Kg/m

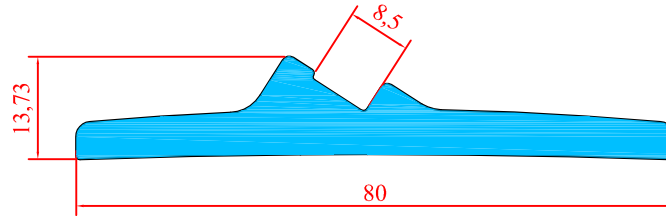

3381
1.670 Kg/m

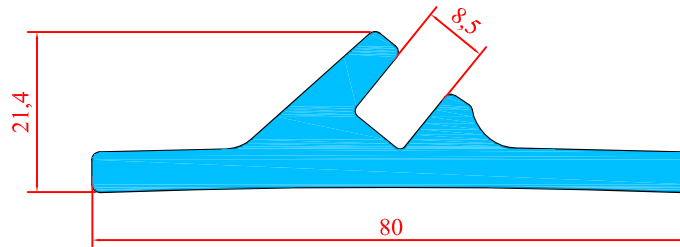



ALÇIN
Alüminyum A.Ş.

TIR PROFİLLERİ

3382
9.550 Kg/m

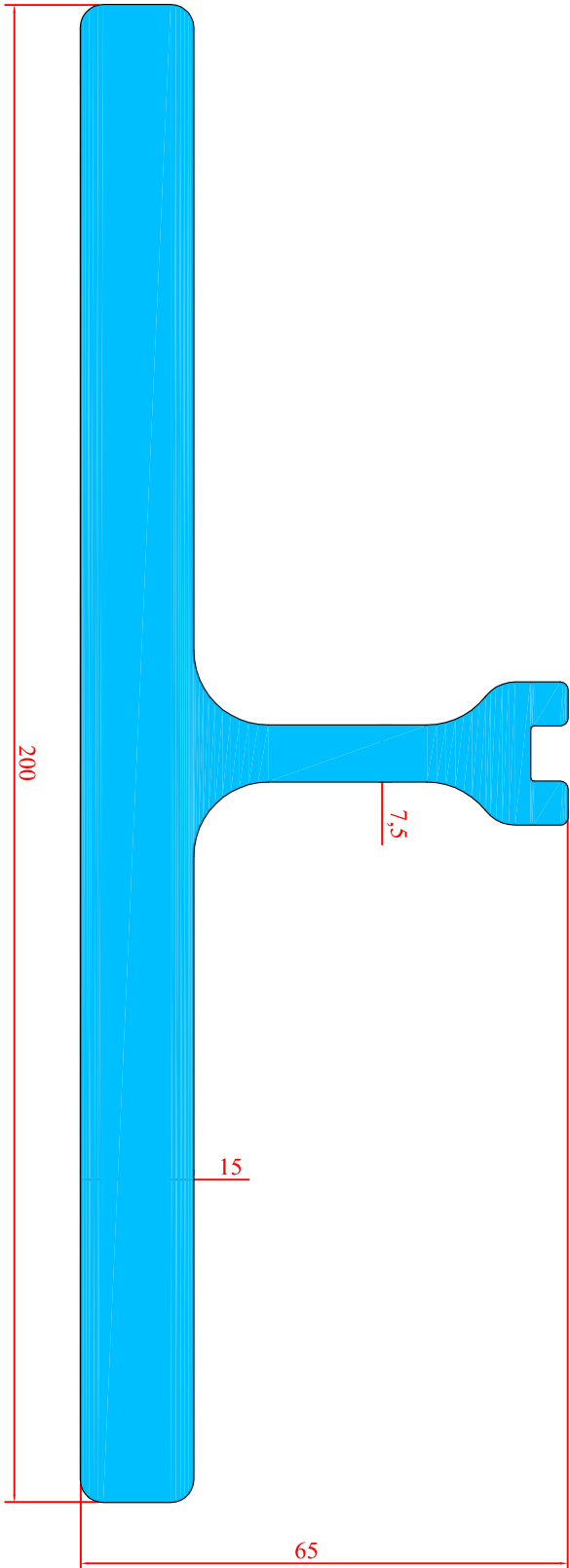



ALÇIN
Alüminyum A.Ş.

TIR PROFİLLERİ

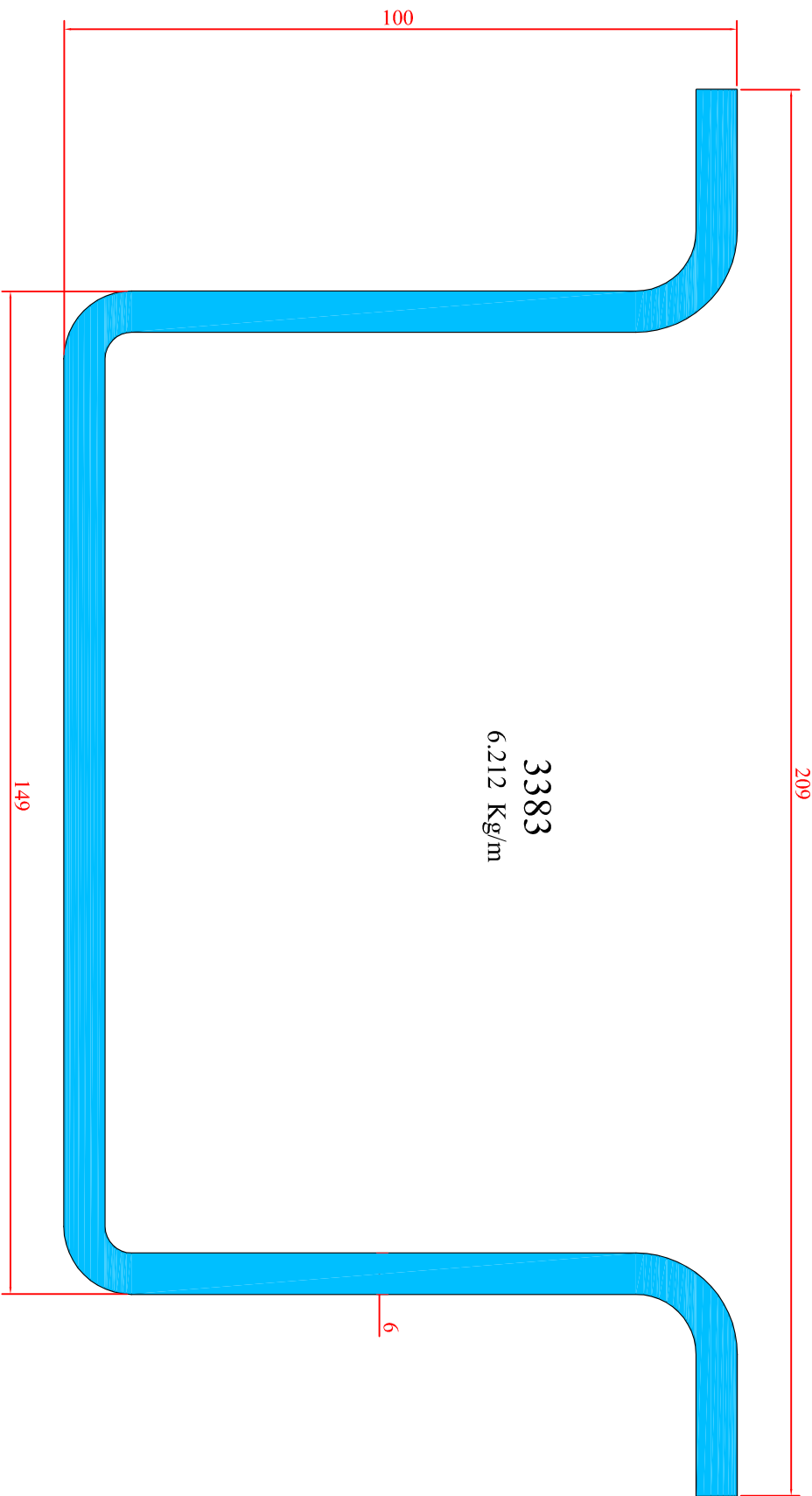

3383
6.212 Kg/m



ALÇIN
Alüminyum A.Ş.

TIR PROFİLLERİ

3399

3.200 Kg/m

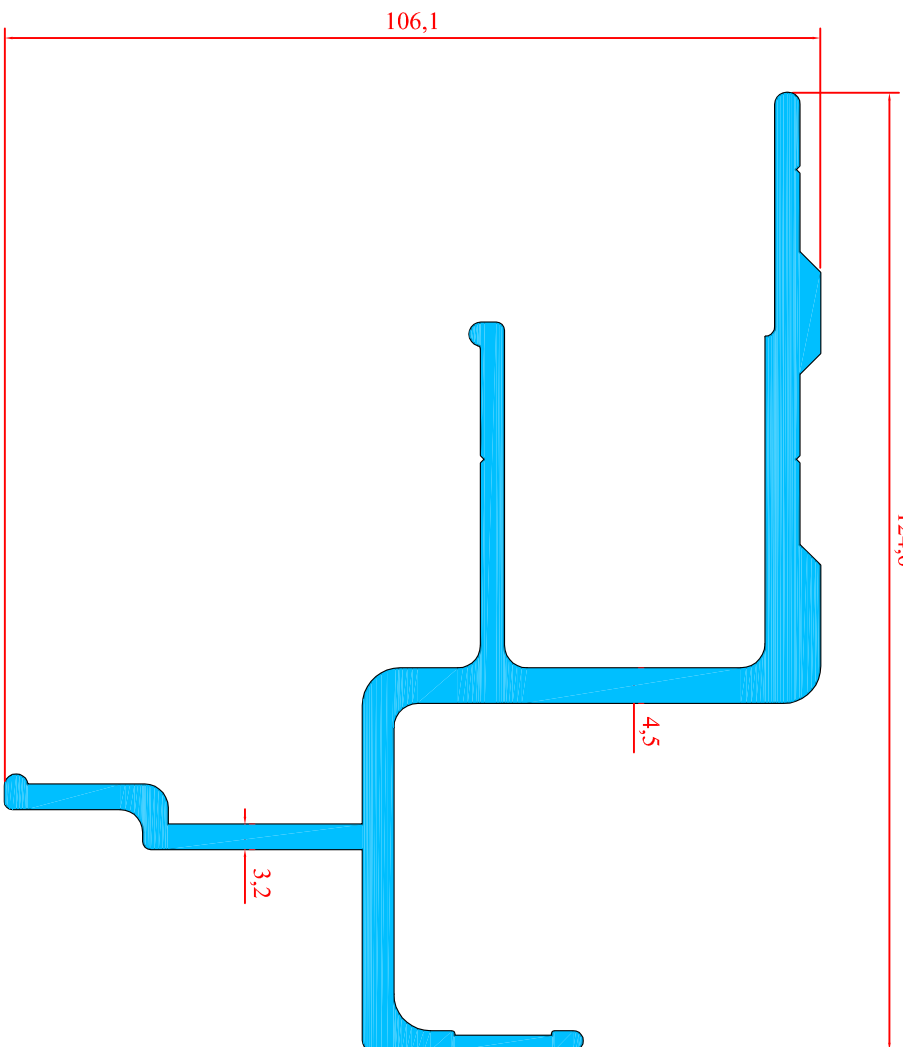



ALÇİN
Alüminyum A.Ş.

TIR PROFİLLERİ

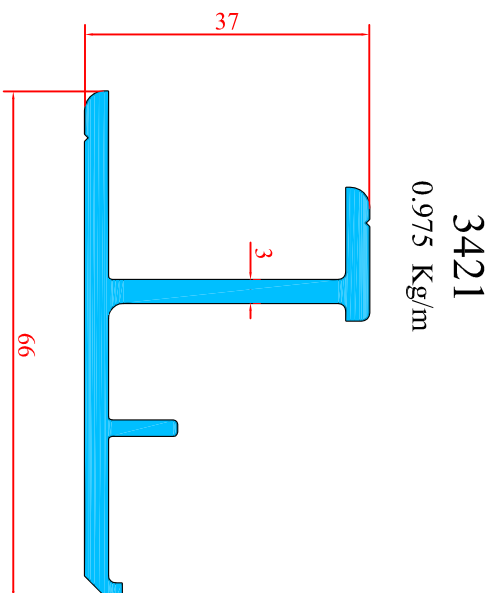
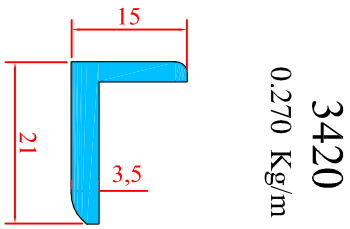
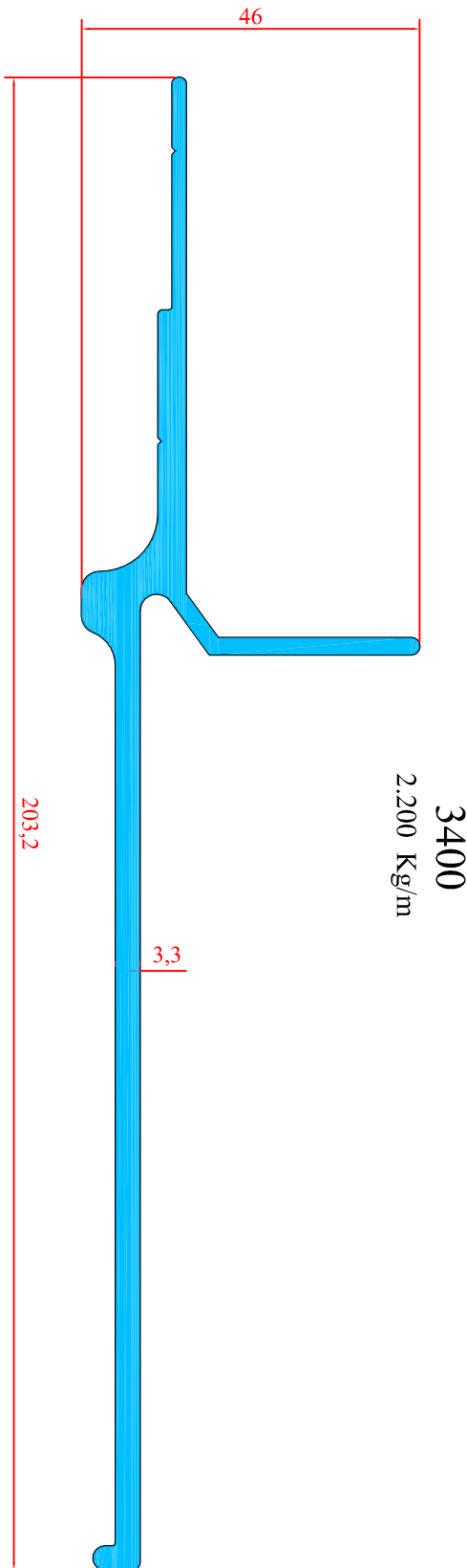

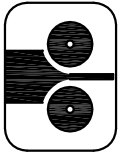

3424
0.843 Kg/m

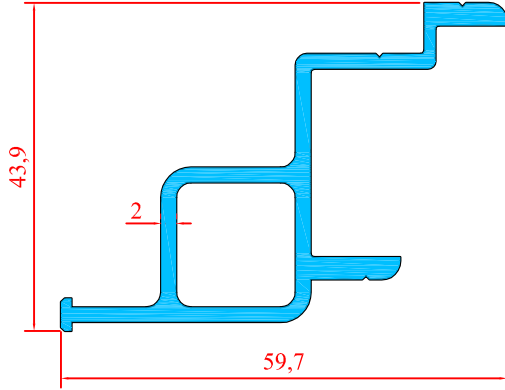

3423
0.750 Kg/m

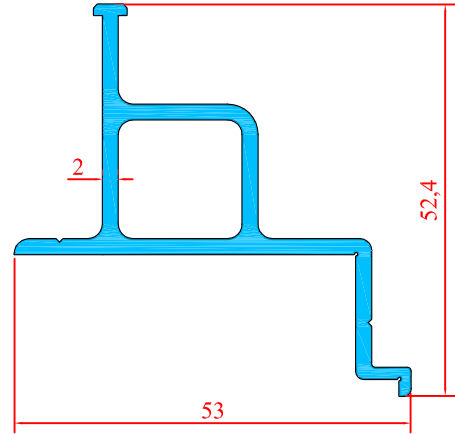

3422
0.505 Kg/m

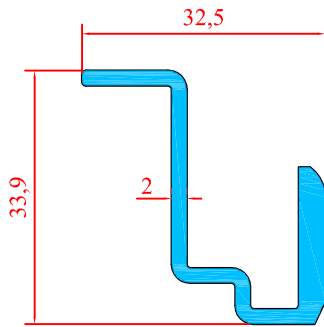

3430
1.493 Kg/m

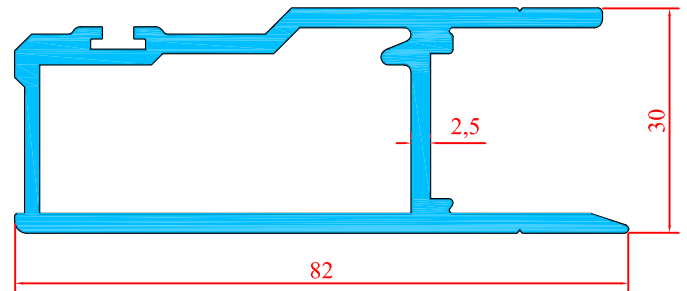

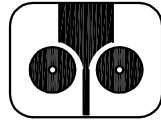

ALÇIN
Alüminyum A.Ş.

TIR PROFİLLERİ

3431

1.958 Kg/m

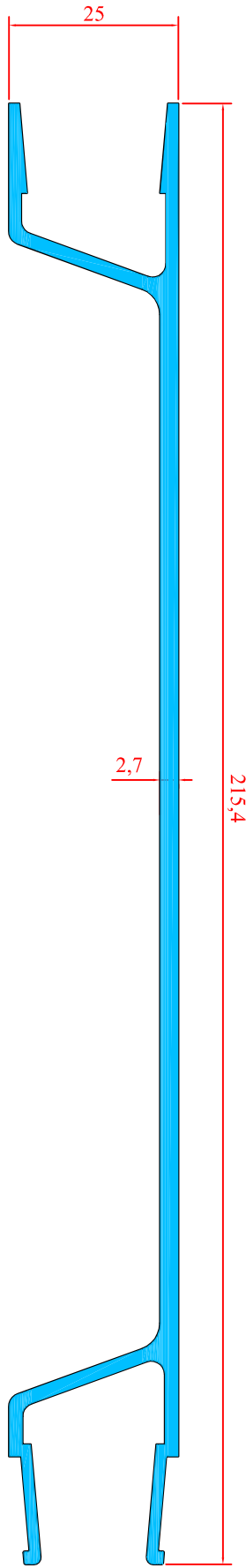

3432

2.420 Kg/m

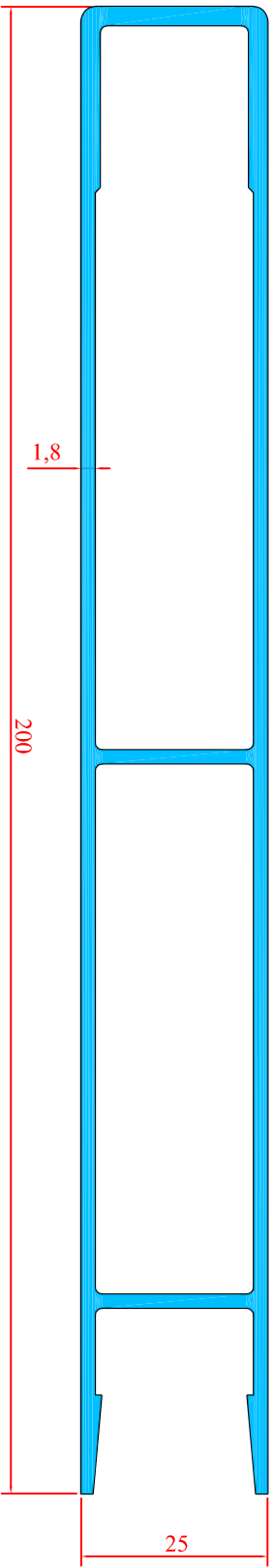



ALÇIN
Alüminyum A.Ş.

TIR PROFİLLERİ

3433

2.957 Kg/m

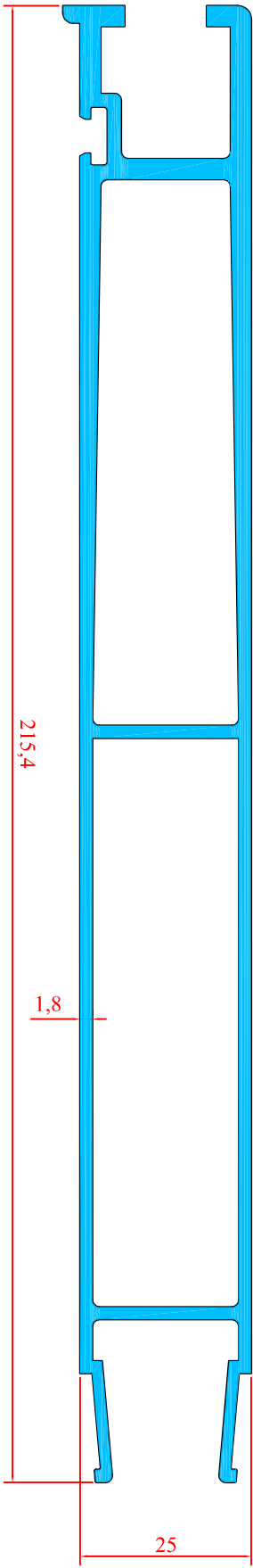

3435

2.437 Kg/m

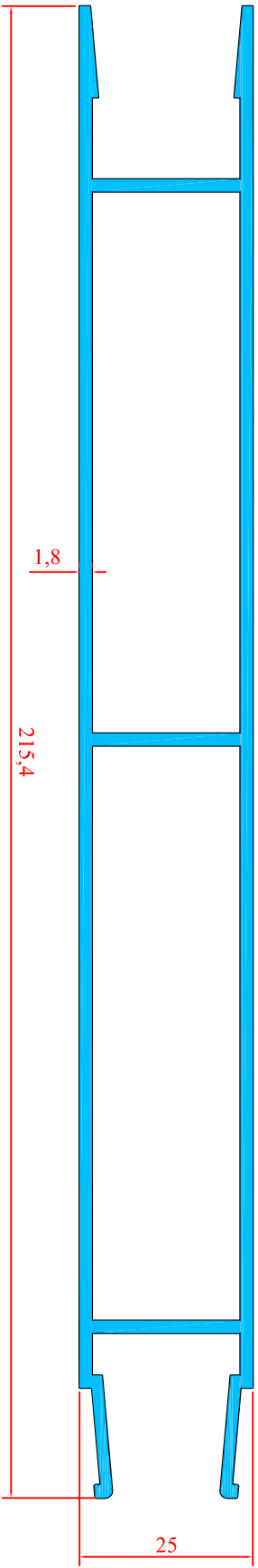

158



ALÇİN
Alüminyum A.Ş.

TIR PROFİLLERİ

3468
1.595 Kg/m

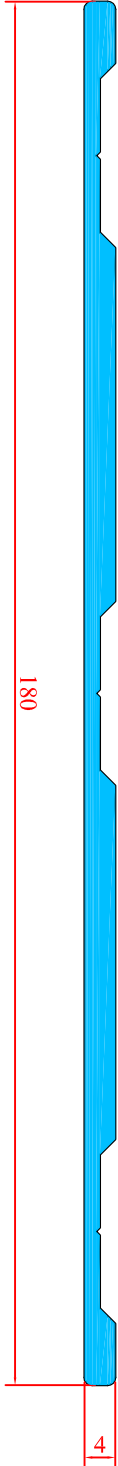

3615
1.095 Kg/m

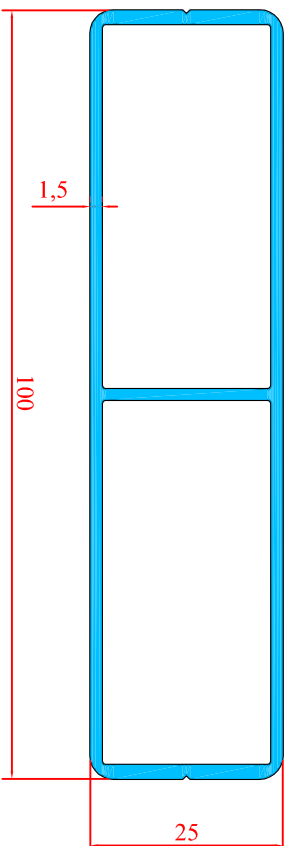



ALÇIN
Alüminyum A.Ş.

TIR PROFİLLERİ

3617
2.234 Kg/m

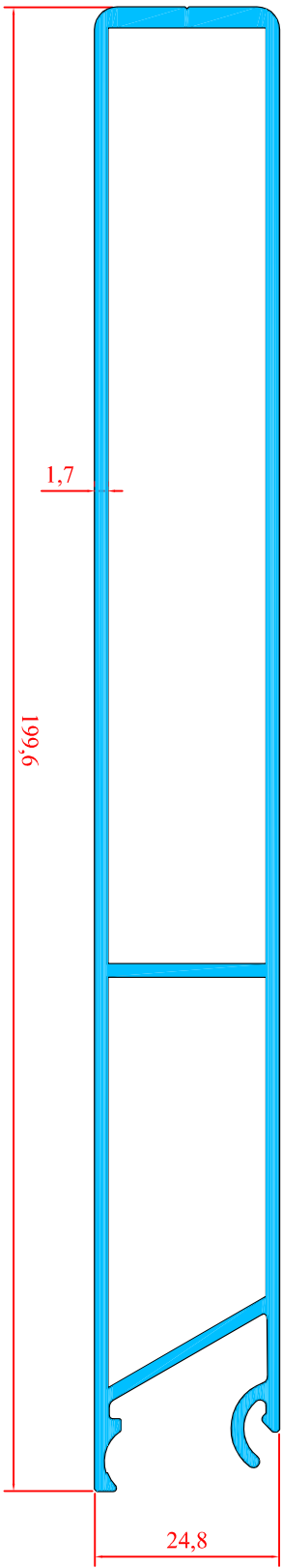

3616
0.911 Kg/m

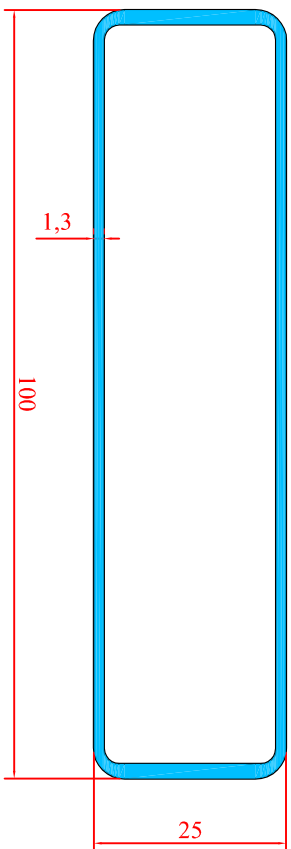



ALÇIN
Alüminyum A.Ş.

TIR PROFİLLERİ

3618

2.730 Kg/m

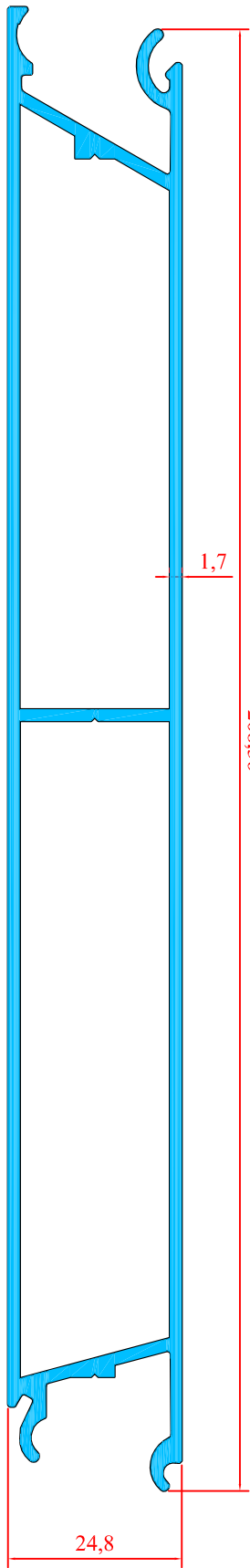

3619

2.564 Kg/m

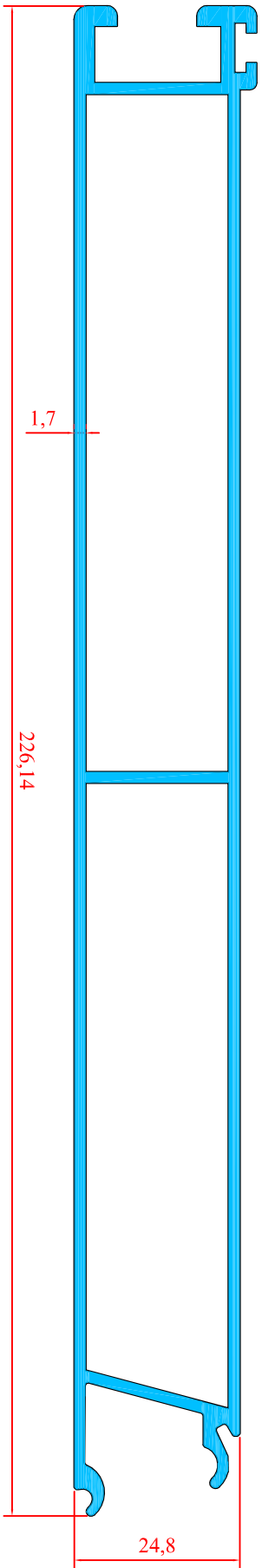



ALÇİN
Alüminyum A.Ş.

TIR PROFİLLERİ

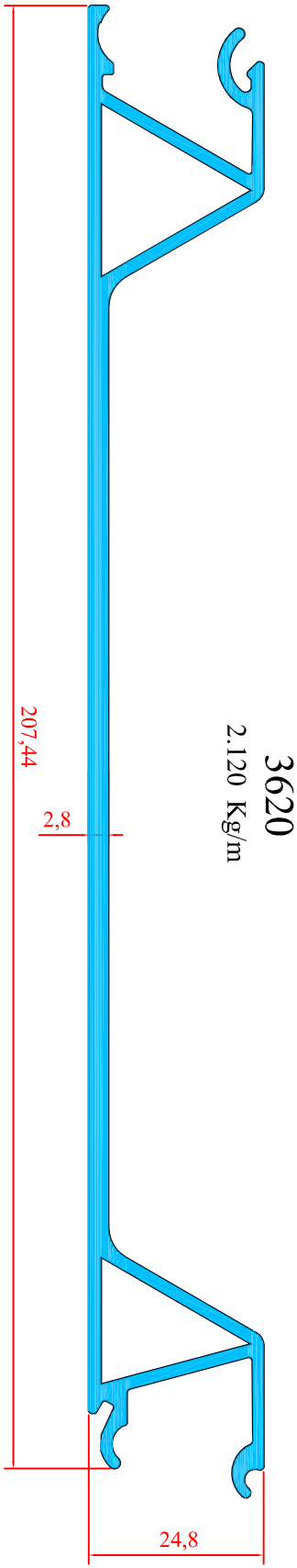

3620

2.120 Kg/m

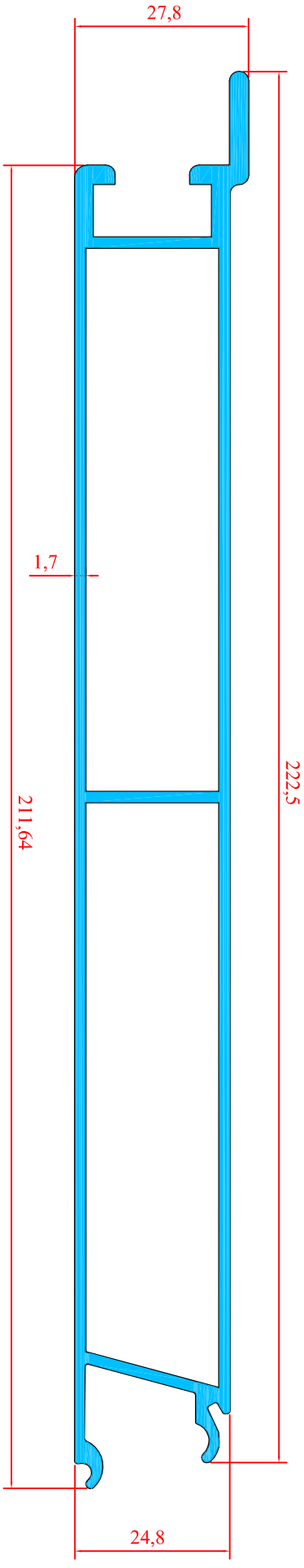

3621

2.547 Kg/m

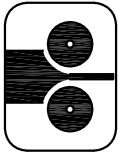

3625

1.864 Kg/m

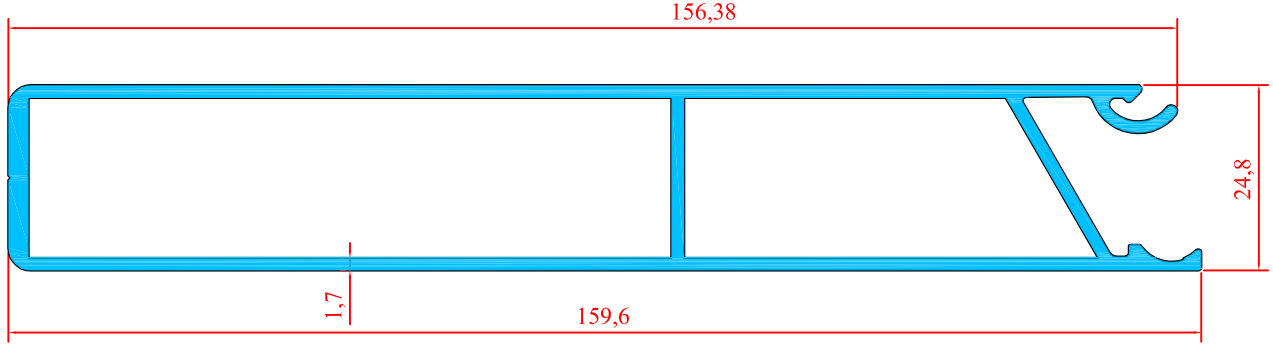

3626

2.070 Kg/m

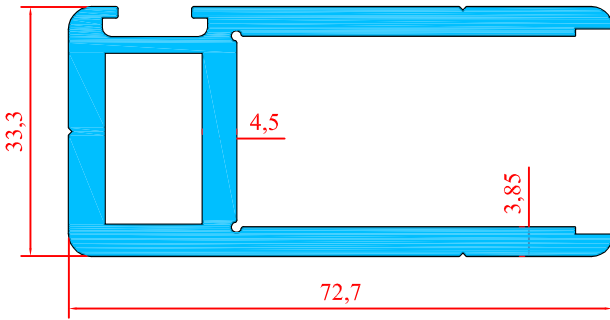

3627

1.710 Kg/m

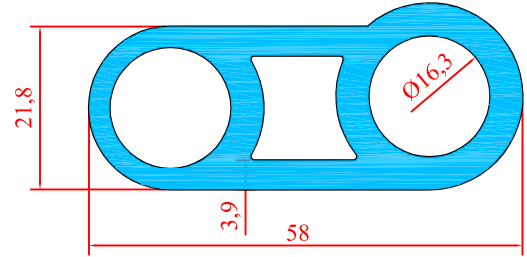

3628

0.840 Kg/m

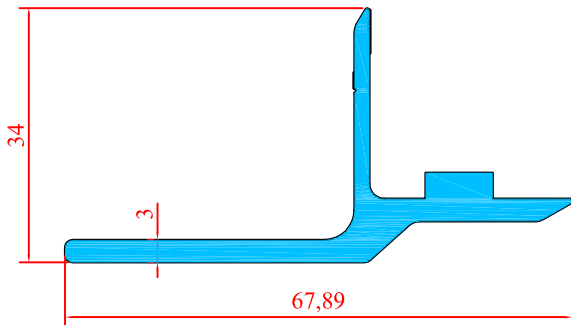

3629

0.462 Kg/m

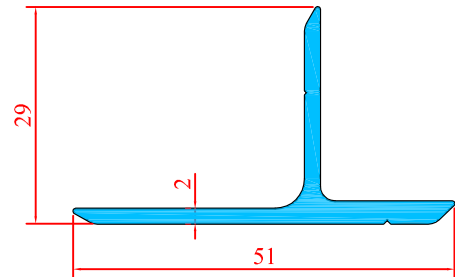



ALÇİN
Alüminyum A.Ş.

TIR PROFİLLERİ

3630

3.203 Kg/m

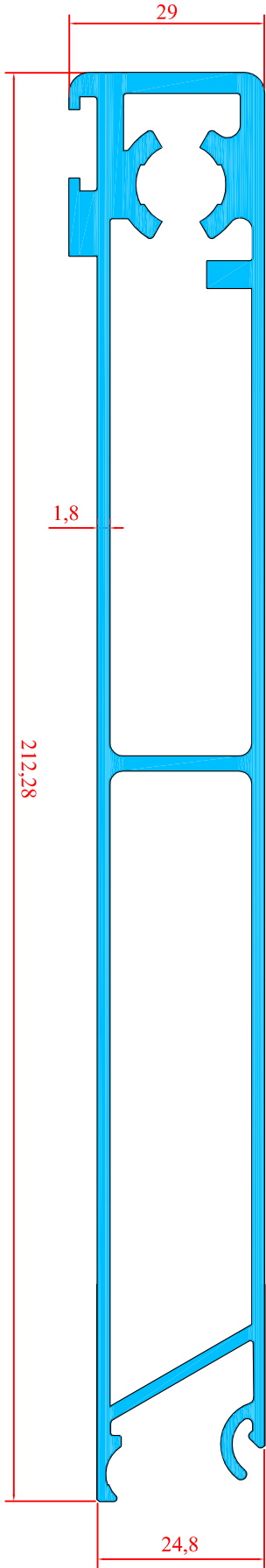

3631

3.144 Kg/m

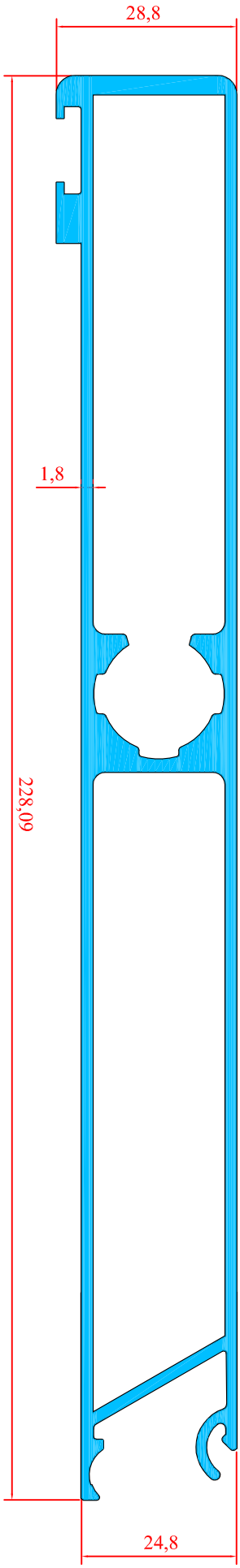



ALÇIN
Alüminyum A.Ş.

TIR PROFİLLERİ

3637

2.226 Kg/m

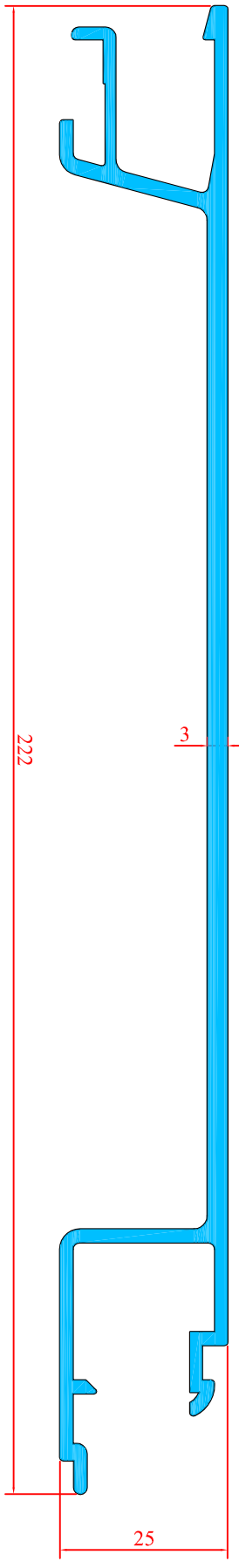

3638

3.767 Kg/m

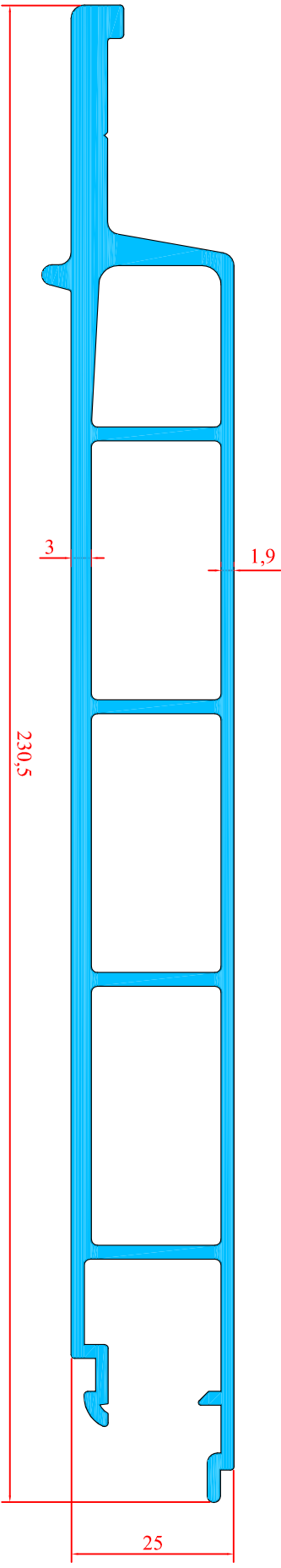

165



ALÇIN
Alüminyum A.Ş.

TIR PROFİLLERİ

3639
2.489 Kg/m

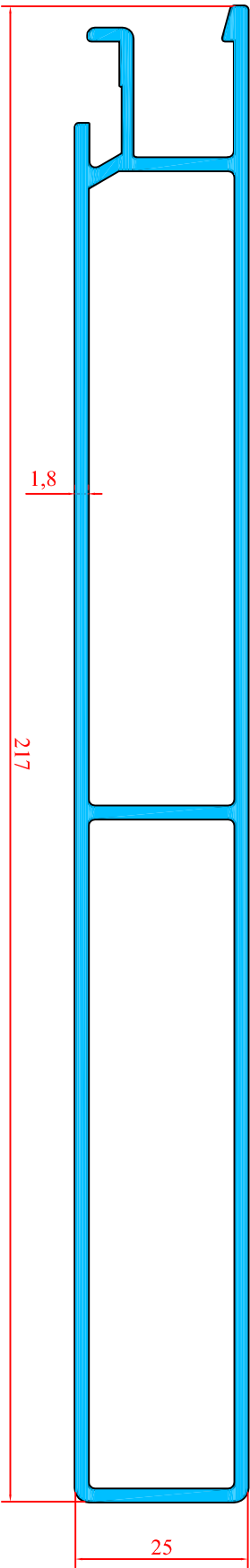

3640
2.560 Kg/m

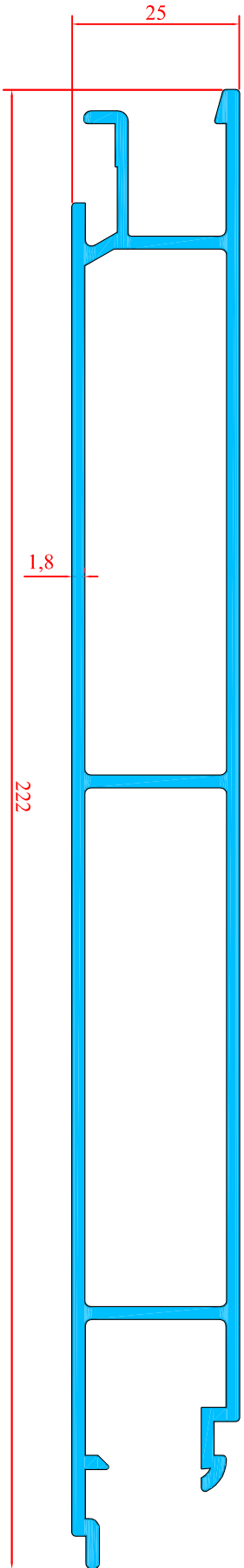

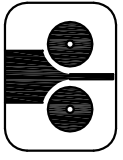

3644

1.618 Kg/m

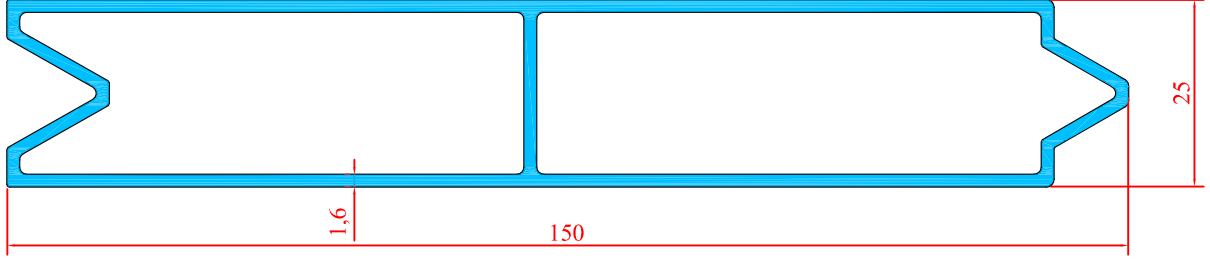

3643

1.440 Kg/m

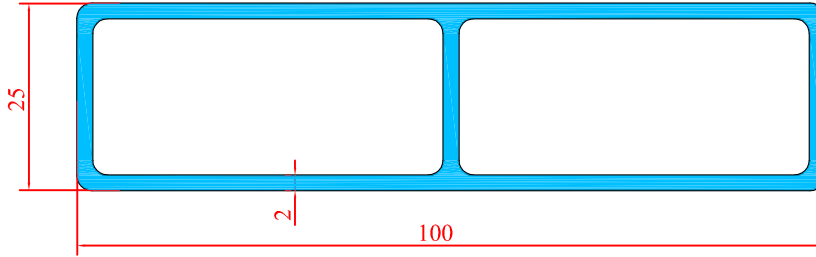

3641

1.417 Kg/m

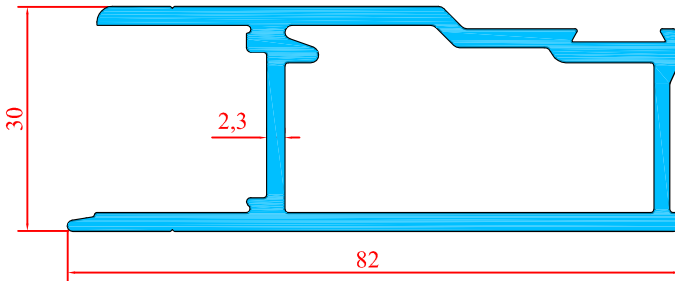

3642

0.759 Kg/m

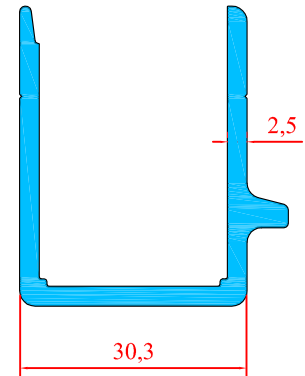



ALÇIN
Alüminyum A.Ş.

TIR PROFİLLERİ

3653

3.144 Kg/m

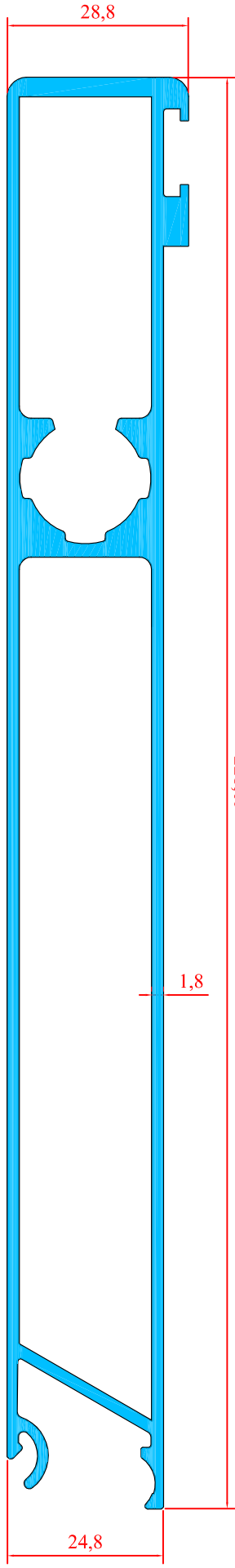

3654

2.220 Kg/m

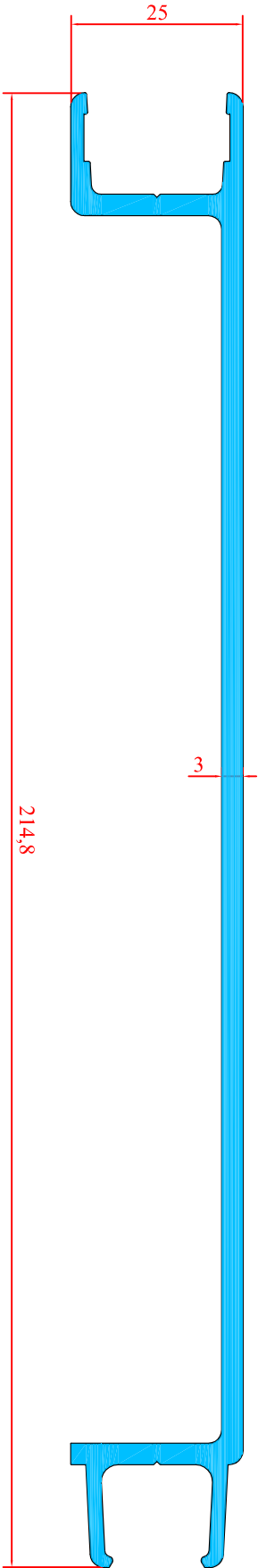



ALÇIN
Alüminyum A.Ş.

TIR PROFİLLERİ

3655

2.711 Kg/m

199,8

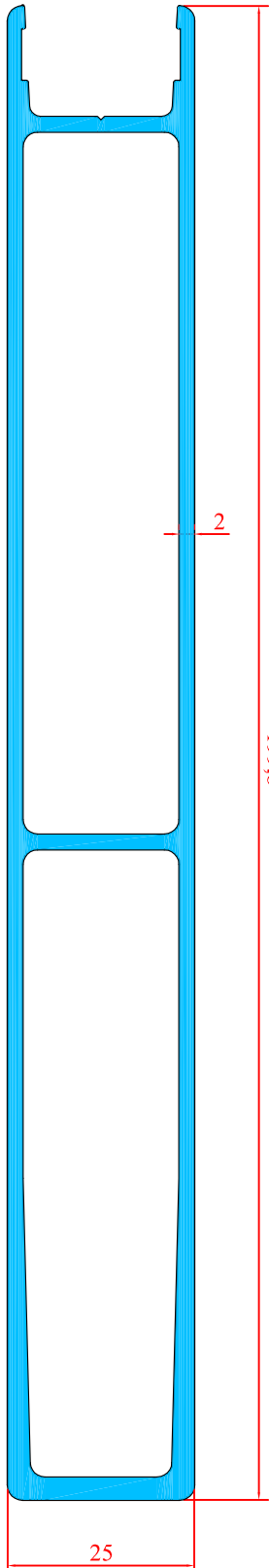

3656

3.047 Kg/m

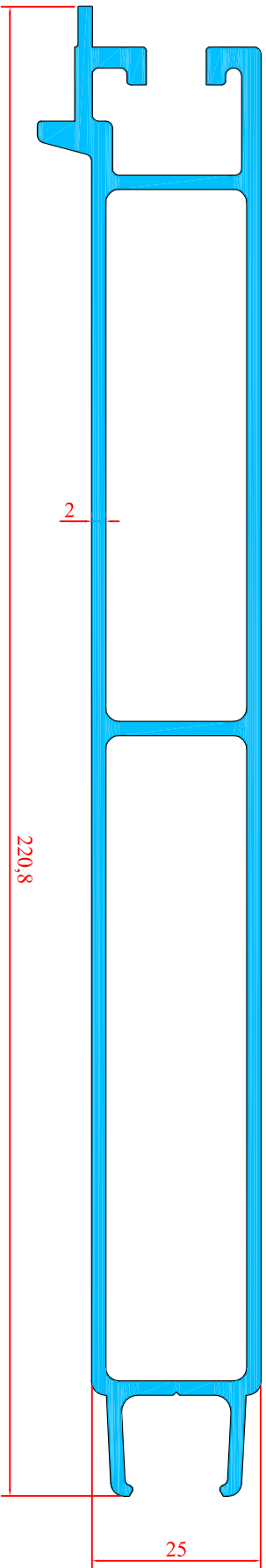

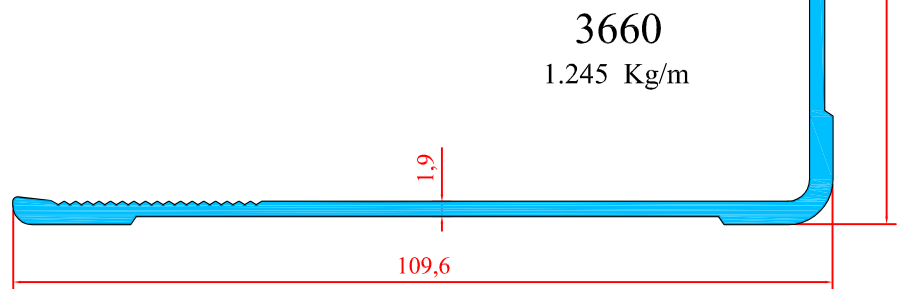
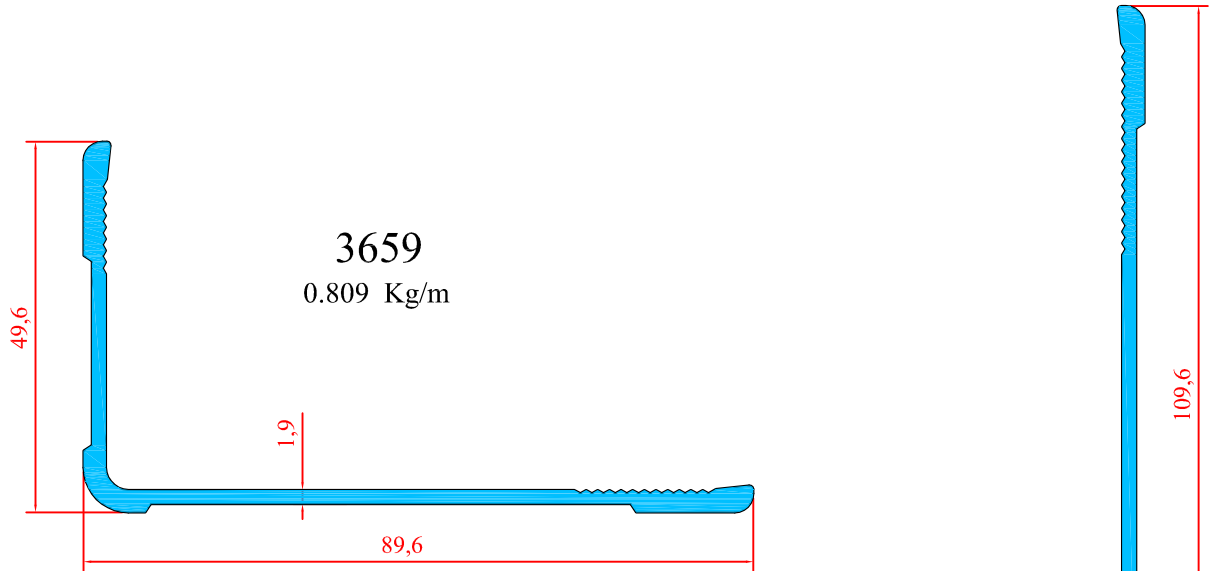
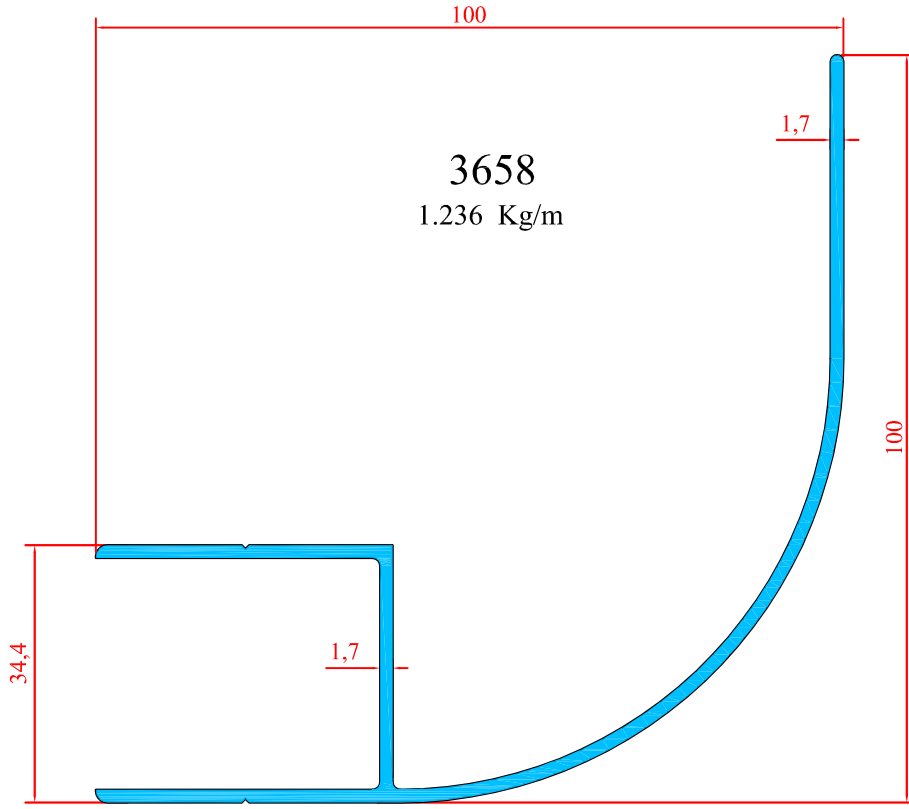
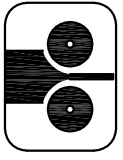

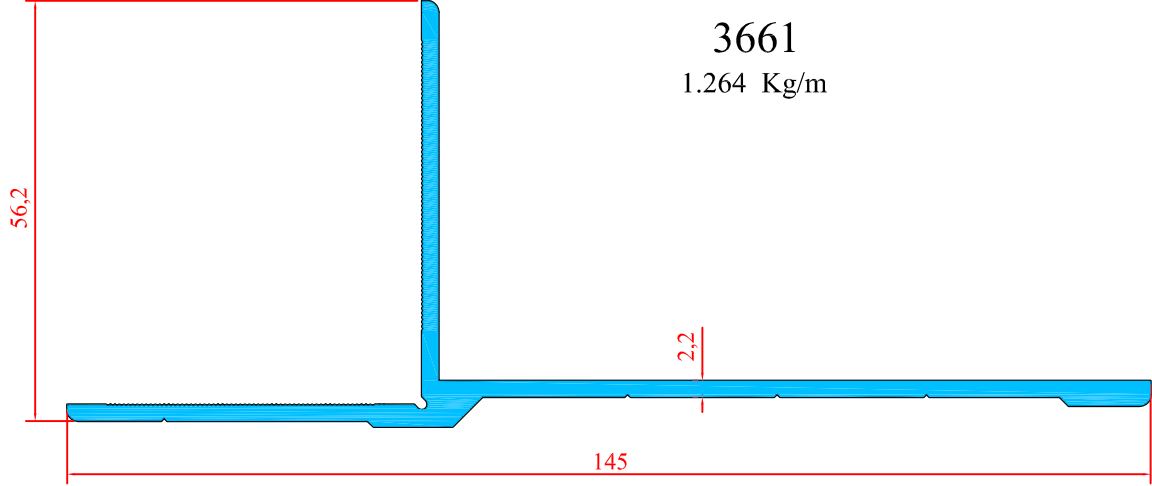
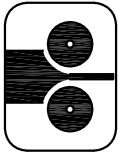

3664
0.945 Kg/m

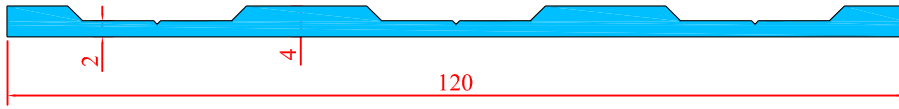

3668
1.510 Kg/m

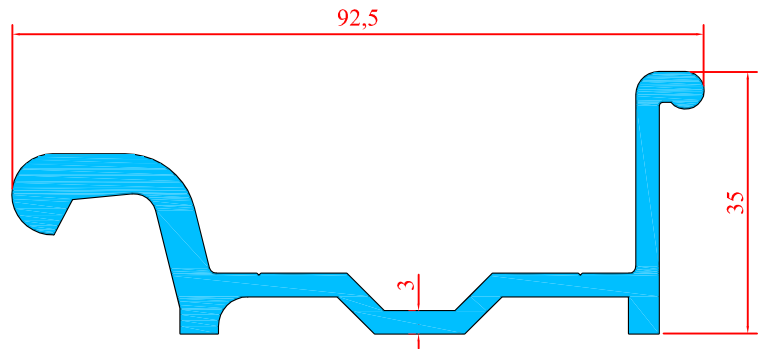

3666
1.902 Kg/m

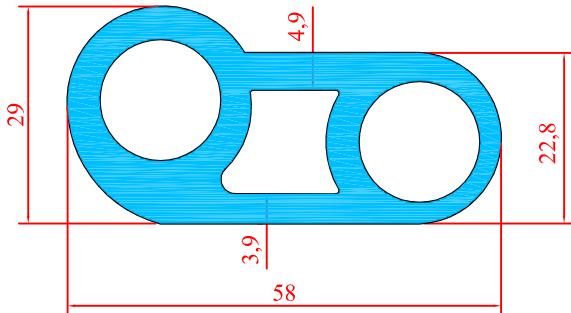



ALÇİN
Alüminyum A.Ş.

TIR PROFİLLERİ

