

1900  
0.690 Kg/m

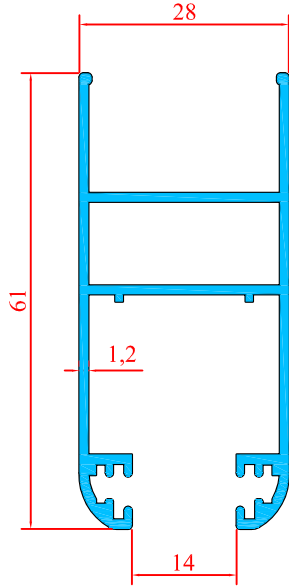

1901  
0.722 Kg/m

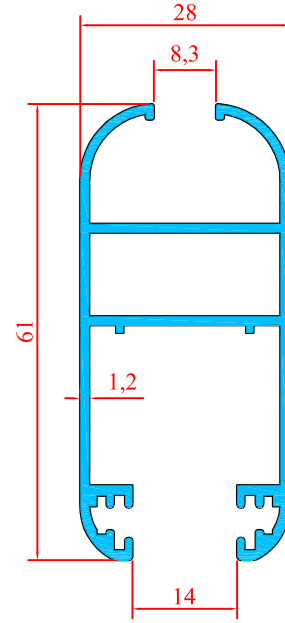

1902  
0.319 Kg/m

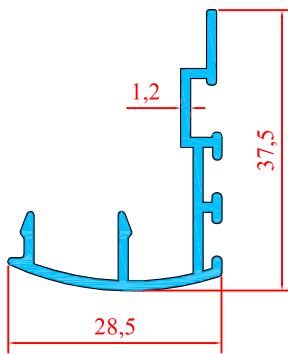

1903  
0.791 Kg/m

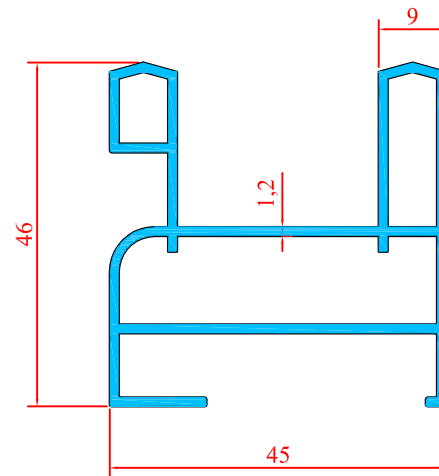

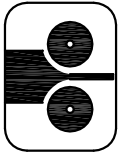

1904  
0.693 Kg/m

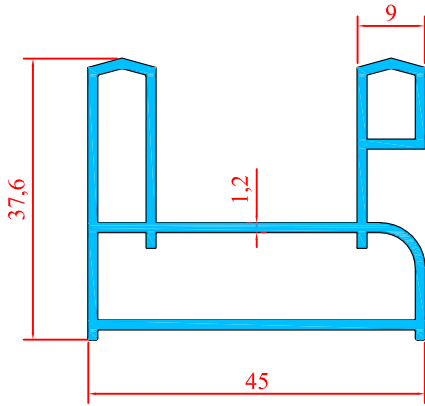

1905  
0.984 Kg/m

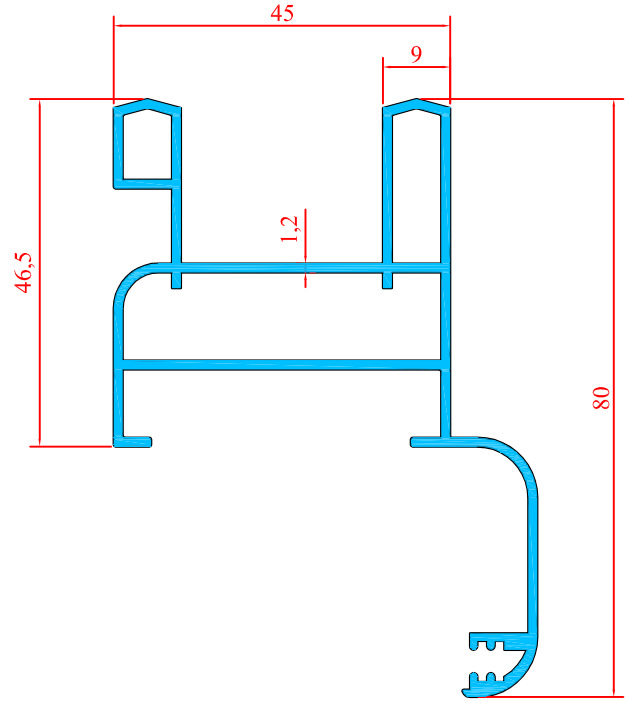

1906  
0.930 Kg/m

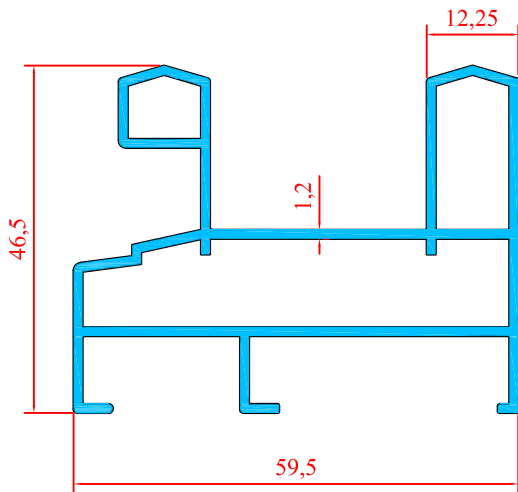

1907  
0.778 Kg/m

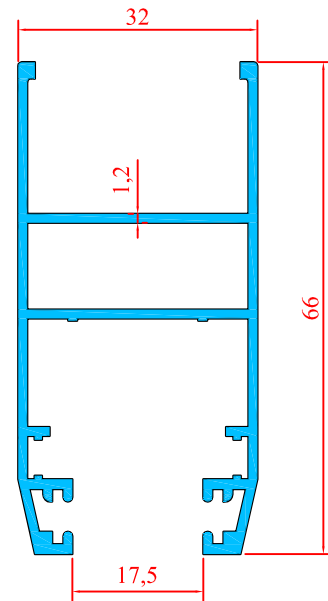

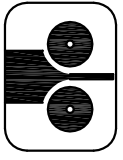

1908  
0.329 Kg/m

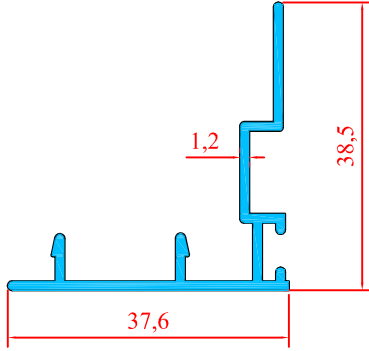

1909  
0.750 Kg/m

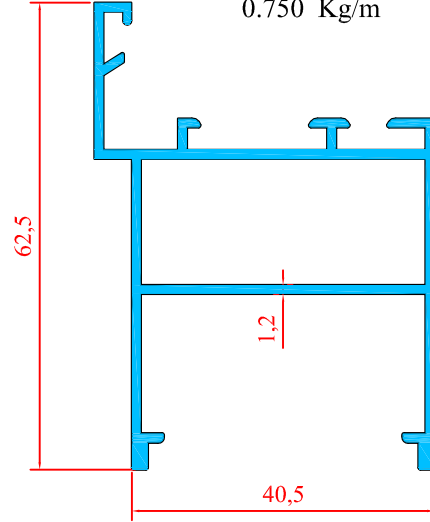

1910  
0.888 Kg/m

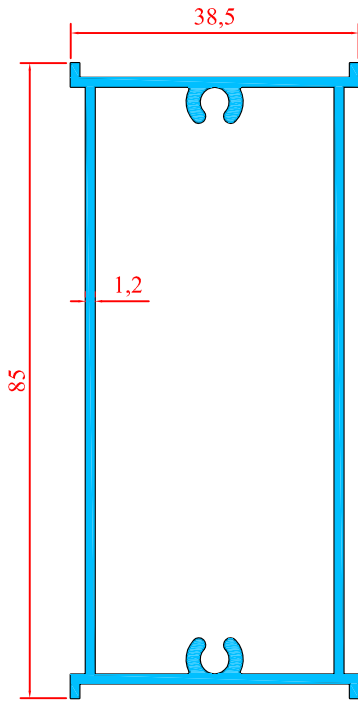

1911  
0.916 Kg/m

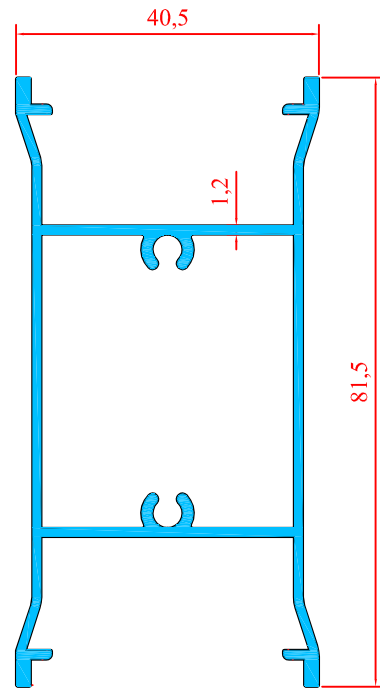

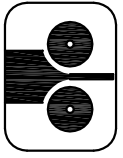

1912  
0.593 Kg/m

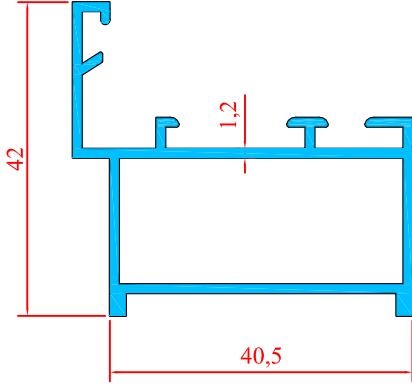

1915  
0.449 Kg/m

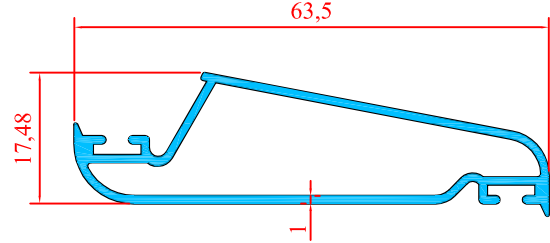

1914  
0.963 Kg/m

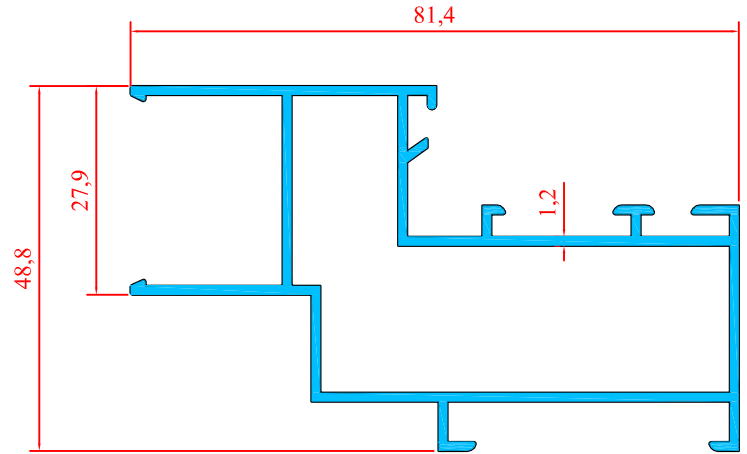

1913  
1.512 Kg/m

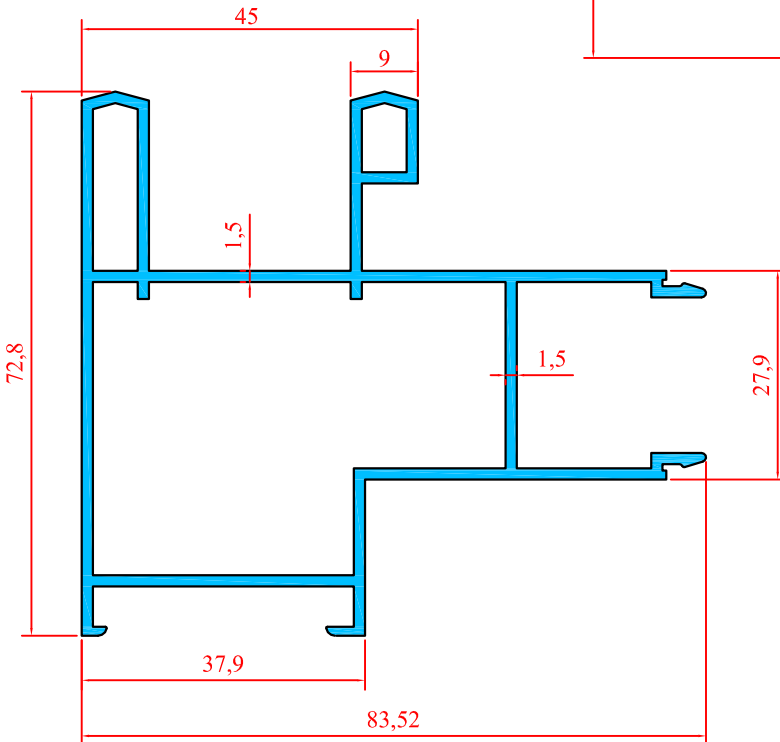

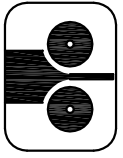

1916  
0.331 Kg/m

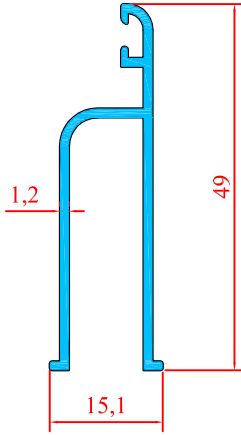

1917  
0.490 Kg/m

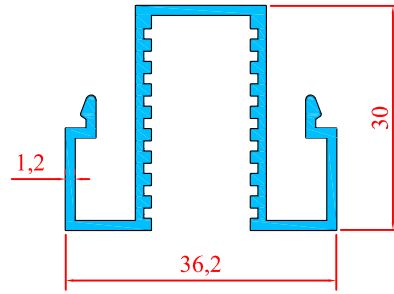

1918  
0.355 Kg/m

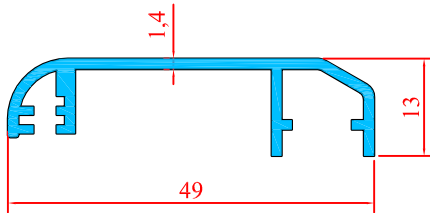

1919  
0.417 Kg/m

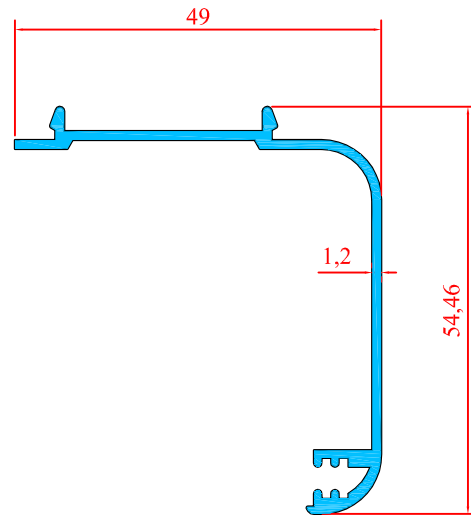

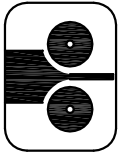

1920  
0.194 Kg/m

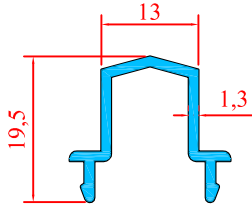

1921  
0.185 Kg/m

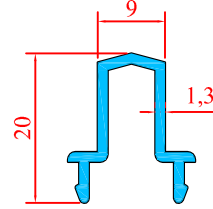

1922  
0.287 Kg/m

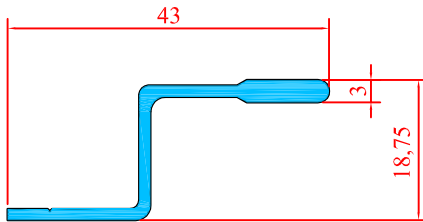

1924  
0.580 Kg/m

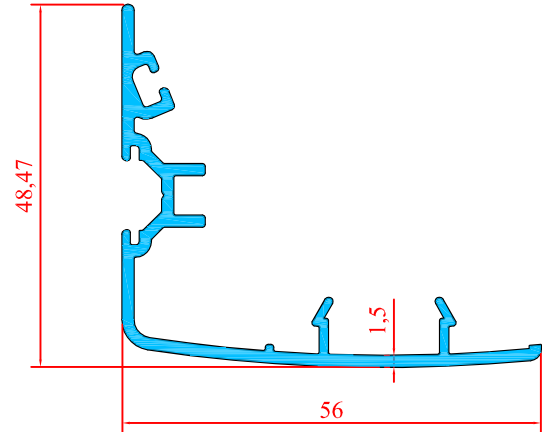

1923  
0.310 Kg/m

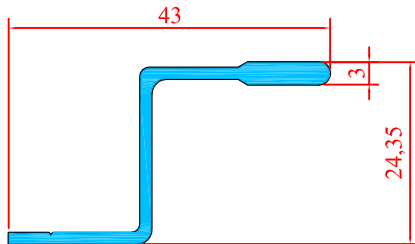



ALÇIN  
Alüminyum A.Ş.

# KIBRIS SÜRME SERİSİ

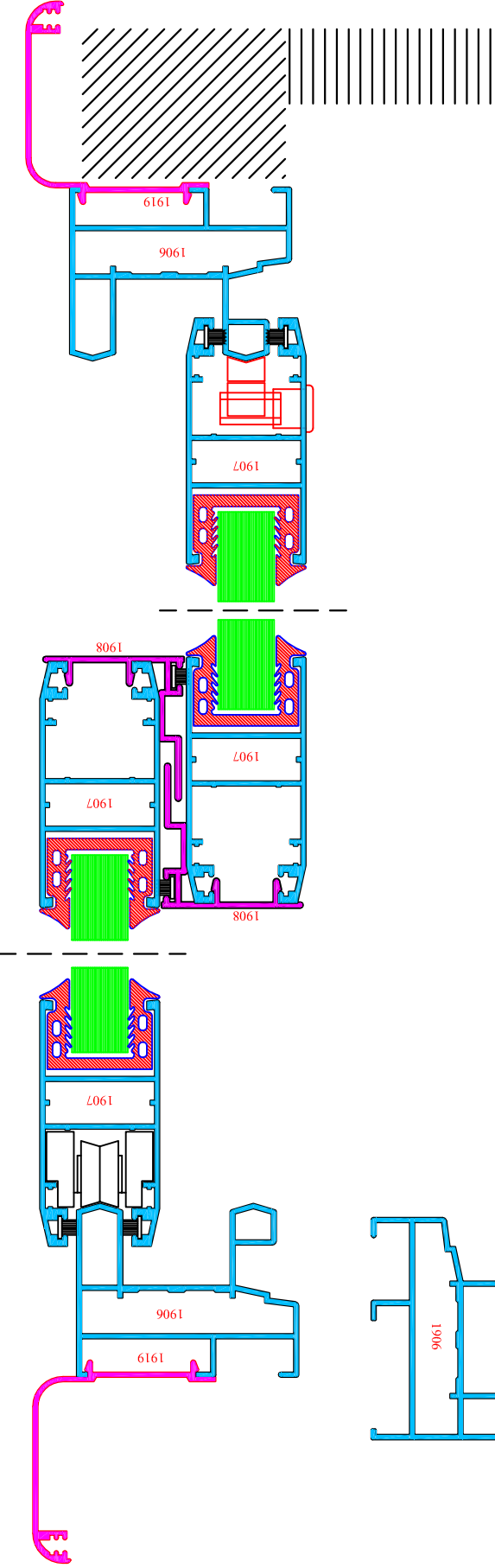
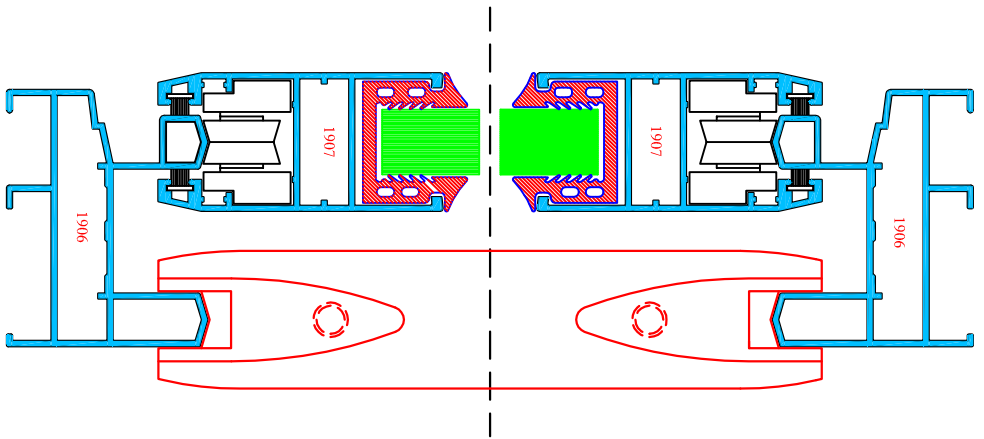
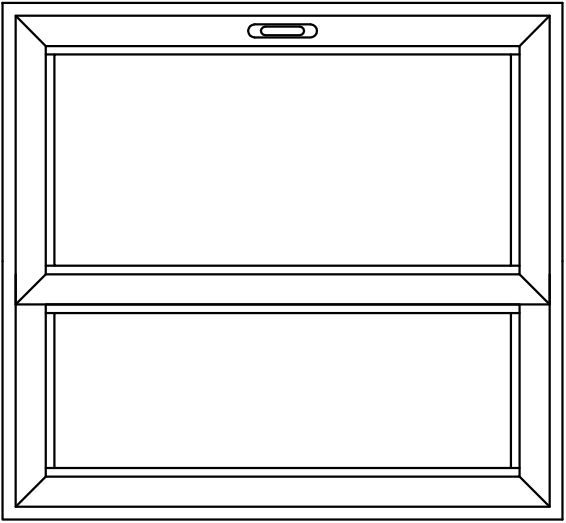

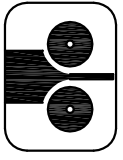

ALÇIN  
Alüminyum A.Ş.

KIBRIS SÜRME SERİ

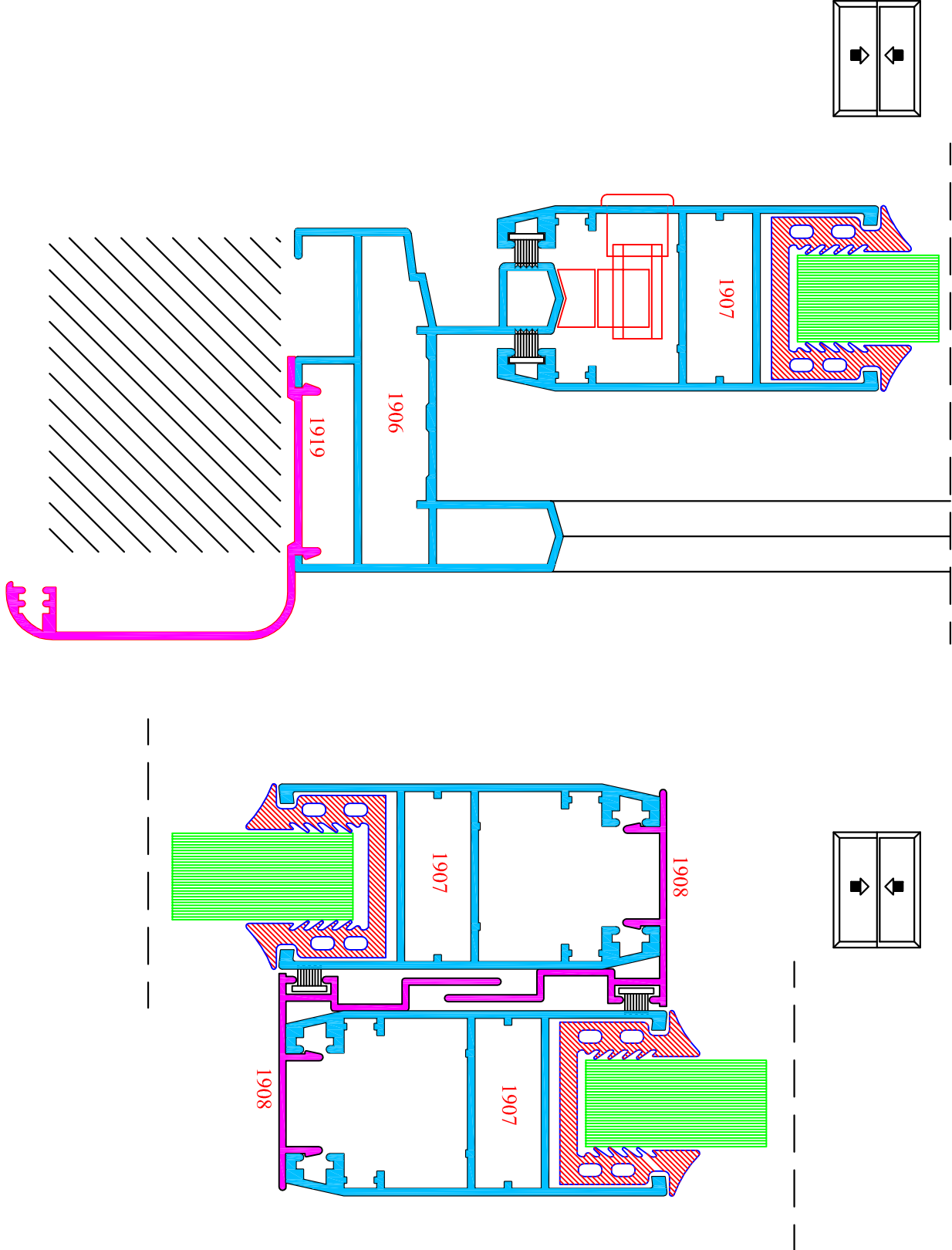



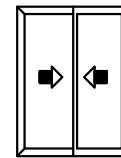
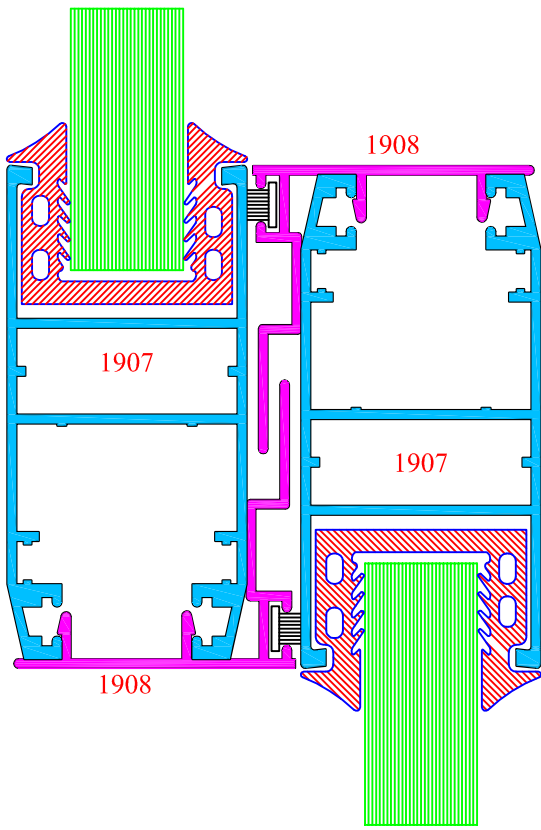
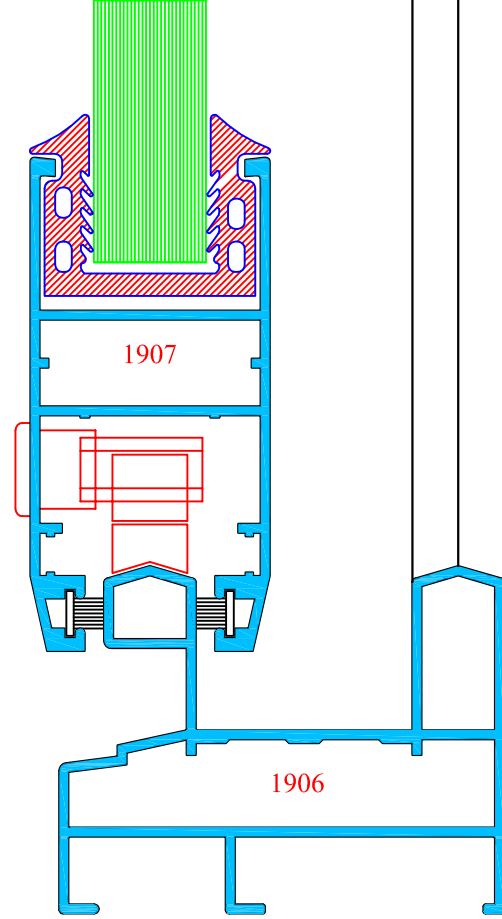
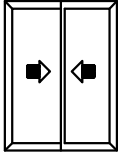
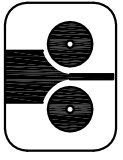

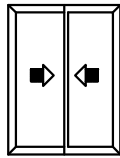
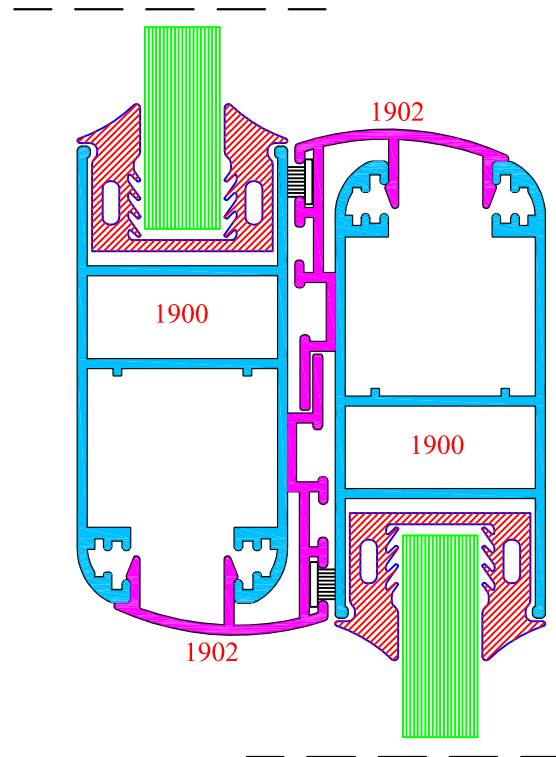
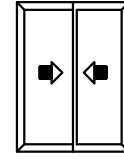
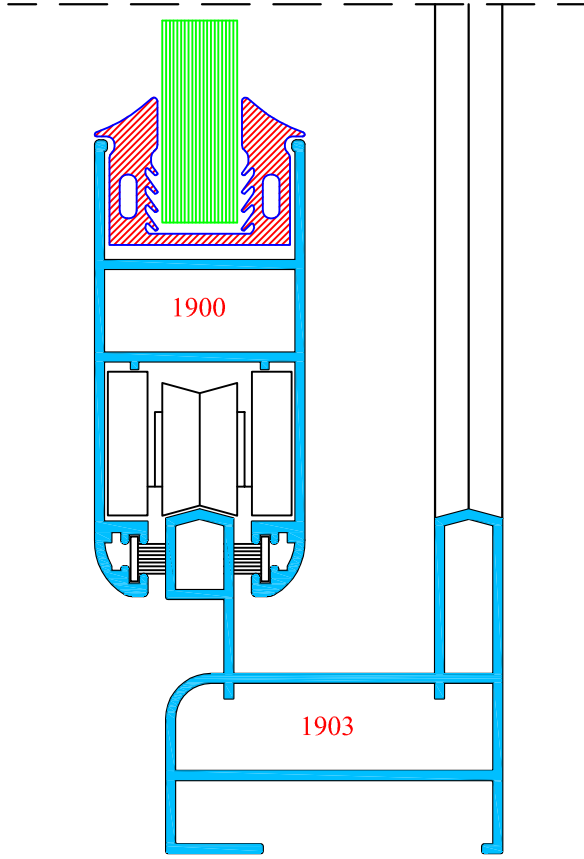
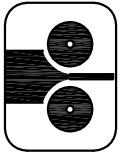

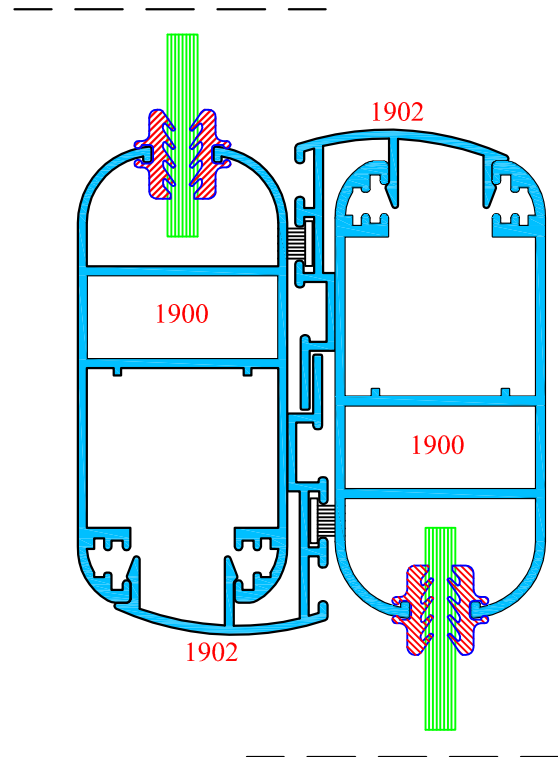
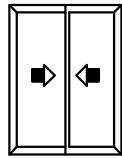
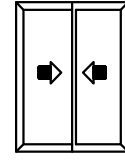
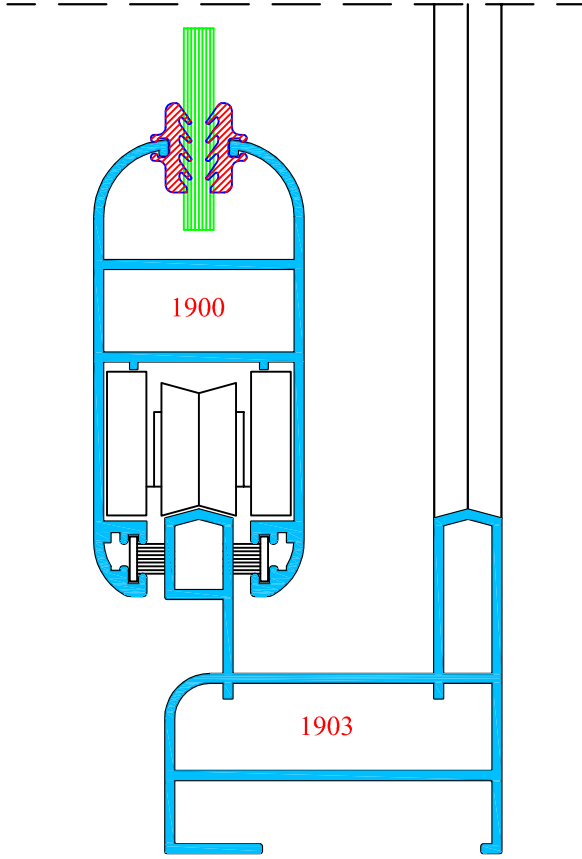
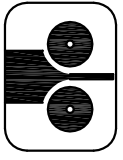



ALÇIN  
Alüminyum A.Ş.

# KIBRIS SÜRME SERİSİ

